

QWC-006

4K camera
with AI ePTZ tracking

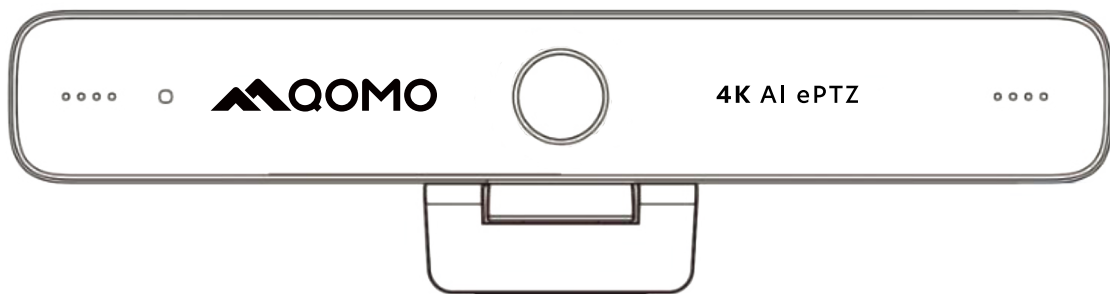

User Manual

Attention

Please read this manual carefully before installation and use of your camera.

1. Caution

- 1.1 Avoid damage to product caused by heavy pressure, strong vibration, or immersion during transportation, storage and installation.
- 1.2 Do not expose this product to liquid, gas or solids that may cause corrosion to the product.
- 1.3 Do not expose the product to rain or moisture.
- 1.4 To prevent the risk of electric shock, do not open the product casing. Repairs should only be carried out by qualified technicians.
- 1.5 Do not use the product beyond the specified temperature, humidity, or power supply specifications
- 1.6 Use a soft, dry cloth when cleaning the camera lens. Wipe it gently with a mild detergent if needed. Do not use strong or corrosive detergents to avoid scratching the lens and affecting the image.
- 1.7 Repairs for this product should be carried out by QOMO support or a qualified QOMO partner. Damage to the product caused dismantling the product by user without permission is not covered by warranty.

2. Electrical Safety

Installation and use of this product must strictly comply with local electrical safety standards.

3. Install

- 3.1 Do not rotate the camera head with force to avoid mechanical damage.
- 3.2 This product should be placed on a stable desktop or other horizontal surface. Avoid uneven surfaces for best image results.
- 3.3 Ensure there are no obstacles within the mechanical arm rotation.
- 3.4 Do not power on before the product installation is complete.

4. Magnetic Interference

Electromagnetic fields at specific frequencies may affect the video image. This product is Class A. It may cause radio interference in household application. Appropriate measure is required.

Content

1. CAMERA INSTALLATION	3
1.1 CAMERA INTERFACES	3
1.2 CAMERA OPERATION	3
2. PRODUCT OVERVIEW	3
2.1 PRODUCT INTRODUCTION	3
2.1.1 Dimension	4
2.1.2 Accessories	4
2.2 MAIN FEATURES	4
2.3 TECHNICAL SPECIFICATIONS	5
2.4 INTERFACE INSTRUCTION.....	6
2.4.1 External Interface.....	6
3. APPLICATION INSTRUCTION	7
3.1 REMOTE CONTROL	7
3.1.1 Keys Introduction	7
3.1.2 Applications	8
3.2 MENU INTRODUCTION.....	9
3.2.1 Main Menu	9
1) System Setting	9
4. MAINTENANCE AND TROUBLESHOOTING	14
4.1 CAMERA MAINTENANCE.....	14
4.2 TROUBLESHOOTING.....	14
5. COPYRIGHT STATEMENT	14

1. Camera Installation

1.1 Camera Interfaces

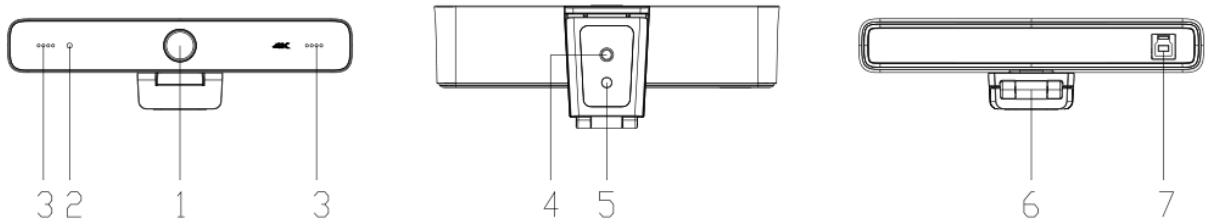

Figure 1.1 Product Interfaces

- 1.Camera lens
- 2.Indicator light
- 3.Built-in microphone

- 4.Tripod adapter
- 5.Positioning hole
- 6.Bracket

- 7.USB3.0 interface

1.2 Camera Operation

- 1) Product Installation: Attach the device to the top of your LCD display, computer monitor, or secure to a tripod mount.
- 2) Connect camera via USB cable to computer, video conference terminal or other USB input device.
- 3) Launch your desired video application, such as video recording programs, web meeting programs (Zoom, Teams, Google Meet) or the QOMO QCamera software. Next, select QWC-006 as the camera options in the application's video settings.

2.Product Overview

2.1 Product Introduction

2.1.1 Dimension

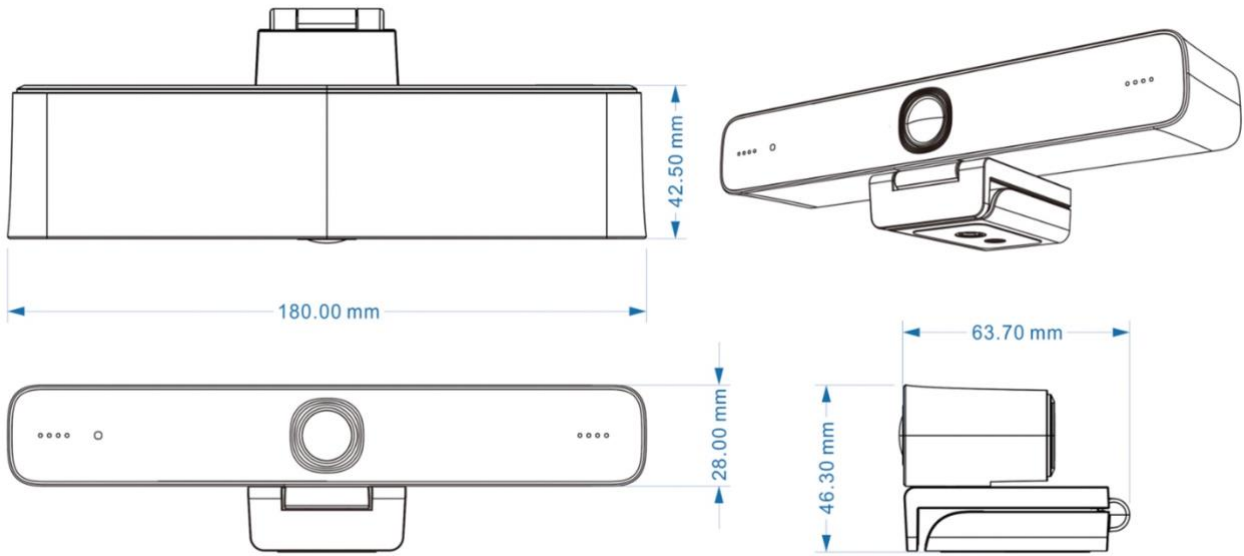

Figure 2.2 Product Dimension

2.1.2 Accessories

Please check for the following accessories when unpacking the box.

Included Accessories	IR Remote Control
	USB 3.0 Cable
	User Manual

2.2 Main Features

QWC-006 is a 4K ultra-high-definition ePTZ camera with AI framing, detecting the number of people in the scene and automatically centering the frame. The camera utilizes advanced ISP processing algorithms to provide vivid images with evenly clear brightness, strong color layering and color rendition.

- **Ultra HD 4K Resolution:** 1/2.8 inch high quality CMOS sensor. Resolution up to 4K with frame rate up to 30fps (MJPG or H.264).
- **ePTZ:** ePTZ and 10X digital Zoom
- **Built-in Microphone:** Dual omni-directional microphones with unique noise suppression technology and effective pickup distance up to 6 meters.
- **Auto Framing:** Superior face detection algorithm to intelligently and automatically frame according to the

number of people in the scene, with people centered in the frame.

- **Wide FOV:** 83°/100°/120° Wide angle and small distortion lens options.
- **Video Output Interface:** USB 3.0
- **Multiple Audio/Video Compression Standard:** Supports H.264, MJPG, YUY2, NV12 video compression for smooth video playback.
- **Low Noise and High SNR:** High SNR image is achieved with low noise CMOS. Even in the case of ultra-low illumination, the picture remains clean and clear.
- **Flexible Clamp:** Standard equipped with mold clamp. Easy to install on any devices, such as LCD screen, laptop, tabletop, and tripod.
- **Easy to Use:** USB 3.0 Plug and play; No need to download a driver.
- **Wide Applications:** Personal video conferencing, enterprise video conferencing, collaboration meeting, remote and hybrid learning, recording lessons and trainings, etc.

2.3 Technical Specifications

Model	QWC-006
Camera Specifications	
Sensor	1/2.8 inch ultra HD 4K CMOS sensor
Effective Pixels	8.28 MP, 16:9
Video Interface	1 Channel USB 3.0 output, Type B; Supports audio signal output
Audio input	2* Built-in microphone pickups
Video Format	MJPG: 3840*2160@30 /2560*1440@30 /1920*1080@30 /1600*896@30 /1280*720@30 /1024*576@30 /960*540@30 /800*600@30 /800*448@30 /720*576@30 /720*480@30 /640*480@30 /640*360@30 /480*270@30 /352*288@30 /320*240@30 H264: 3840*2160@30 /2560*1440@30 /1920*1080@30 /1600*896@30 /1280*720@30 /1024*576@30 /960*540@30 /800*600@30 /800*448@30 /720*576@30 /720*480@30 /640*480@30 /640*360@30 /480*270@30 /352*288@30 /320*240@30 YUY2: 1920*1080@30 /1280*720@30 /1024*576@30 /800*600@30 /800*448@30 /640*480@30 /640*360@30 /480*270@30 /320*180@30 NV12: 1920*1080@15 /1280*720@30 /1024*576@30 /800*600@30 /800*448@30 /640*480@30 /640*360@30 /480*270@30 /320*180@30
View Angle	138° (D) /120°(H)/68°(V)
Focal Length	f=1.89mm
Aperture	F2.0±5%
Digital Zoom	10X
Minimum Illumination	0.1 Lux (F1.8, AGC ON)
White Balance	Auto / Manual
Focus	Manual
Exposure	Auto / Manual
BLC	On / Off
SNR	≥50dB

USB Feature	
Operation Systems	Windows 7 (1080p or lower) , Windows 8.1, Windows 10; macOS™ 10.10 or higher; Android; Linux (UVC support)
Video Compression Format	YUY2, NV12, MJPG, H264
USB Audio	Supports
USB Communication Protocol	UVC, UAC
PTZ Control	Yes; Auto & Manual

Hardware Requirement	2.4 GHz Intel@ Core 2 Duo or higher, 2GB or higher, USB 3.0 port (USB 3.0 for 4K)
-----------------------------	---

Other Parameter	
Input Voltage	5V
Input Current	1A (max)
Power Consumption	5W (max)
Stored Temperature	-10°C~+60°C
Stored Humidity	20%~90%
Working Temperature	-10°C~+50°C
Working Humidity	20%~80%
Dimension	180mm*42.5mm*46.3mm
Weight	Around 0.3kg
Working Environment	Indoor
Accessory	User Manual, USB 3.0 cable

2.4 Interface Instruction

2.4.1 External Interface

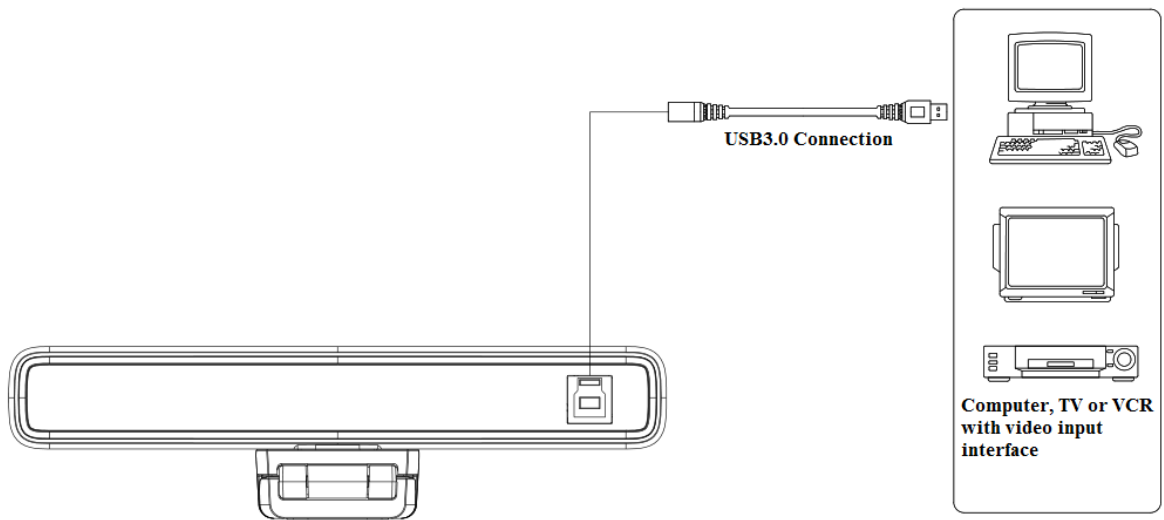

Figure 2.4 Wiring Diagram

3.Application Instruction

3.1 Remote Control

3.1.1 Keys Introduction

1. Infrared indicator light

2. Stand By

The device enters standby mode after pressing once, and the device re-displays the picture after pressing again.

3. Menu Button

Enter/exit the OSD menu or return to the previous menu.

4. Pan/Tilt Control

Up: press  Down: press 

Left: press  Right: press 

Press and hold any of the direction keys, and the camera pan will move continuously.
 Camera lens will reset to the middle position

5. Number key

Number keys 1, 2, 3: Preset position settings

Note: Short press for 1s [preset position recall]; Long press for 3s [set new preset position]

Long press for 5s [deletes the preset]

6. Zoom Control

 : press to zoom in

 : press to zoom out

7. Auto Framing Function Key



3.1.2 Applications

1) In this manual, “press the key” means a click rather than a long-press. A mention will be given if a long-press for more than one second is required.



1) Infrared indicator light



1. Red light: Sending commands
2. No light: Command is not being sent

2) Standby, Menu Setting



1. Standby button : Turn on or off the camera capture.
2. Menu key : call up the camera OSD menu

3) Pan/Tilt Control



- Pan up: press **【▲】** key Pan down: press **【▼】** key
Pan to the left: press the **【◀】** key
Pan to the right: press the **【▶】** key
Reset image to middle position: press **【OK】** key
Long press the up, down, left or right rotation buttons to pan continuously. Release the button when panned to the desired position.

4) Preset Positions

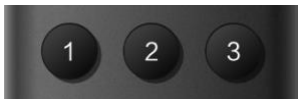

1. Save a preset position: Long press (3s) one of the number keys 1~3, and the current image frame will be preset to the corresponding number key.
2. Call preset position: Press the number key corresponding to the desired preset position.
3. Delete preset position: Long press (5s) Press the number key corresponding to the preset that you want to delete. Once released, the preset will be deleted.

5) Zoom Control



1. Zoom in the lens: press the **【🔍】** key
2. Zoom out the lens: press **【🔍】** key
3. Long press these two buttons and it will continue to zoom in/out; Release it halfway to stop.



6) Auto Framing Function On/Off



Turn On/Off the AI Auto Framing Function

3.2 Menu Introduction

3.2.1 Main Menu

Press the Menu key  on the remote to display the menu screen. Use the directional arrows to navigate the selections, and the **【OK】** key to make a selection. To exit or go back a menu page, click the Menu key  again.

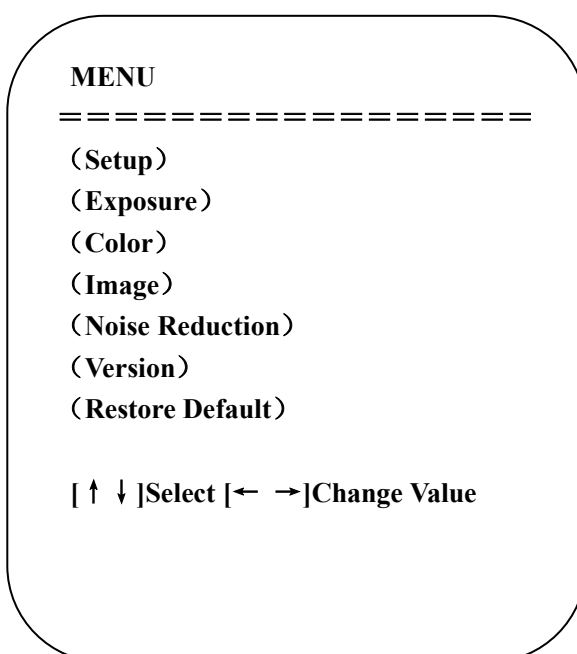

1) System Setting

Select (Setup) for the following system settings options.

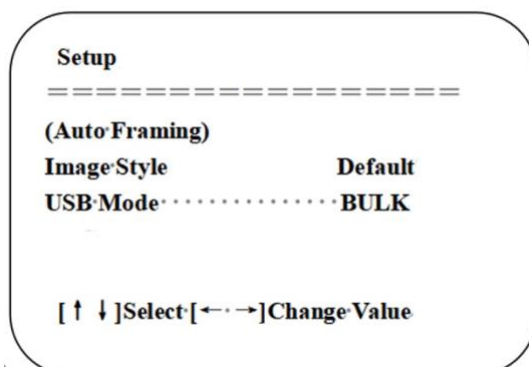

Image Style: Default/ Normal/ Clarity/ Bright/ Soft

Intelligent zoom: On/ Off

2) Exposure Setting

Select (Exposure) to adjust the camera exposure settings.

EXPOSURE	
=====	
Mode	Auto
EV	OFF
BLC	OFF
Flicker	50Hz
G.Limit	6
DRC	3

[↑ ↓]Select [← →]Change Value

Mode: Auto/ Manual/ SAE/ Brightness

EV: On/Off (Auto mode)

Compensation Level: -7~7 (Auto mode when EV is ON)

BLC: On/Off (Auto mode)

Anti-Flicker: OFF/50Hz/60Hz (Auto / Brightness modes)

Gain Limit: 0~15 (Auto /Brightness modes)

WDR: Off, 1~8

Shutter Priority: 1/30, 1/50, 1/60, 1/90, 1/100, 1/120, 1/180, 1/250, 1/350, 1/500, 1/1000, 1/2000, 1/3000, 1/4000, 1/6000, 1/10000 (Manual / SAE modes)

Brightness: 0~23 (Brightness mode)

Gain: 0 to 15 (Manual / SAE modes)

3) Color

Select (Color) to adjust the image color settings.

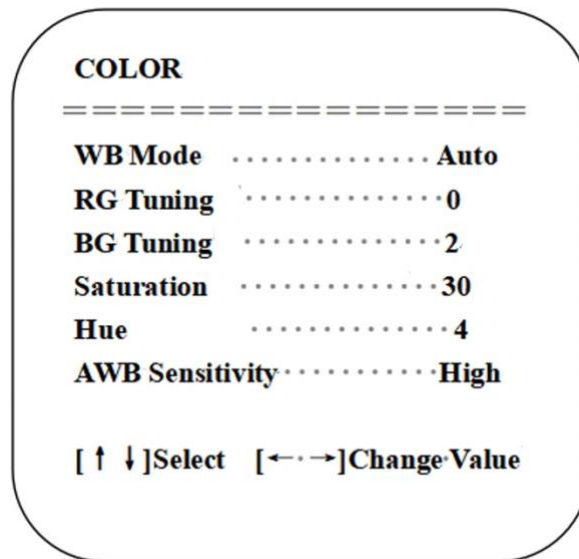

WB Mode: Auto/ Manual/ One Push/ Specified color temperature

Saturation: 0-50

AWB Sensitivity: high/middle/low (only available in Auto mode)

Chroma: 0~8

RG Tuning: -10 - 10

BG Tuning: -10 - 10

Red Gain: 0-255

Blue Gain: 0-255

Color Temperature: 2400K~7100K

4) Image

Select (Image) to adjust the following image settings.

IMAGE	
=====	
Brightness	7
Contrast	7
Sharpness	5
Flip-H	OFF
Flip-V	OFF
B&W-Mode	Color
Gamma	Default
Low-Light Mode	Off
[↑ ↓]Select [← →]Change Value	

Brightness: 0~14

Contrast: 0~14

Sharpness: 0~15

Flip-H: Flip image horizontally

Flip-V: Flip image vertically

B&W Mode: Color, black/white

Gamma: Default/0.34/0.39/0.47/0.5

Low-Light Mode: On/Off

5) Noise Reduction

Select (Noise Reduction) to adjust the noise reduction settings.

NOISE REDUCTION	
=====	
NR-2D	OFF
NR-3D	4
[↑ ↓]Select [← →]Change Value	

2D Noise Reduction: Auto, close, 1~7

3D Noise Reduction: Close, 1~8

6) Version

Select (Version) to view the device firmware version.

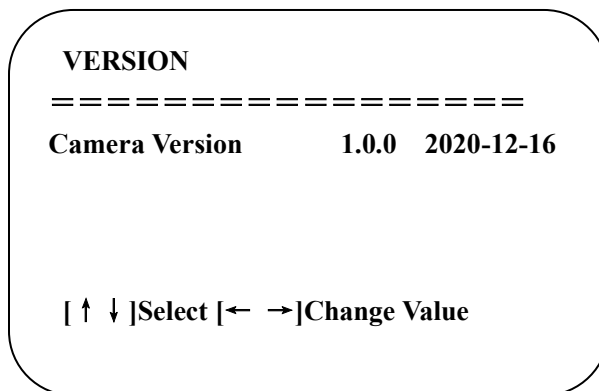

7) Restore Default

Select (Restore Default) to restore image settings to the factory default settings.

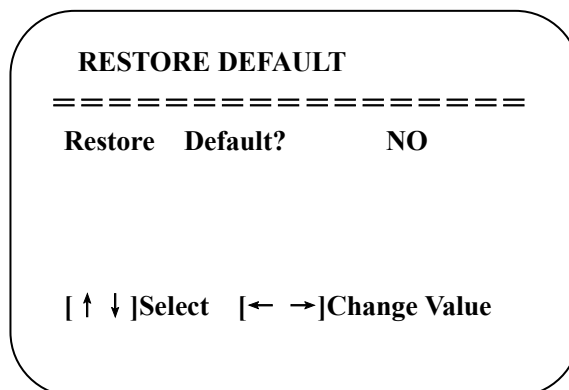

Restore default: Yes/No.

Note: Color style and video format cannot be restored to factory default.

4. Maintenance and Troubleshooting

4.1 Camera Maintenance

- 1) Please power off the camera and disconnect the power adapter and socket, when the camera is not in use.
- 2) Use a soft cloth or tissue to clean the camera cover.
- 3) Use a soft, dry cloth when cleaning the camera lens. Wipe it gently with a mild detergent if needed. Do not use strong or corrosive detergents to avoid scratching the lens and affecting the image.

4.2 Troubleshooting

1) No video output

- a. Check if the USB cable is connected correctly and the power indicator light is on.
- b. Restart the QWC-006 device.
- c. Restart the computer.
- d. Check whether the video output cable or video display is normal.
- f. Check whether the camera is recognized by the PC.

2) Flickering image issue

- a. Check the USB cable quality and make sure it is connected securely.

5. Copyright Statement

All contents in this manual and its copyright are owned by QOMO, LLC. Reproduction and distribution of this document without the written permission of the owner is prohibited. This manual does not contain any guarantees, standpoints, or implications. Product specification and information in this manual is for reference only and subject to change without notice. All rights reserved.