

Interactive Touch Screen User Manual V1.0

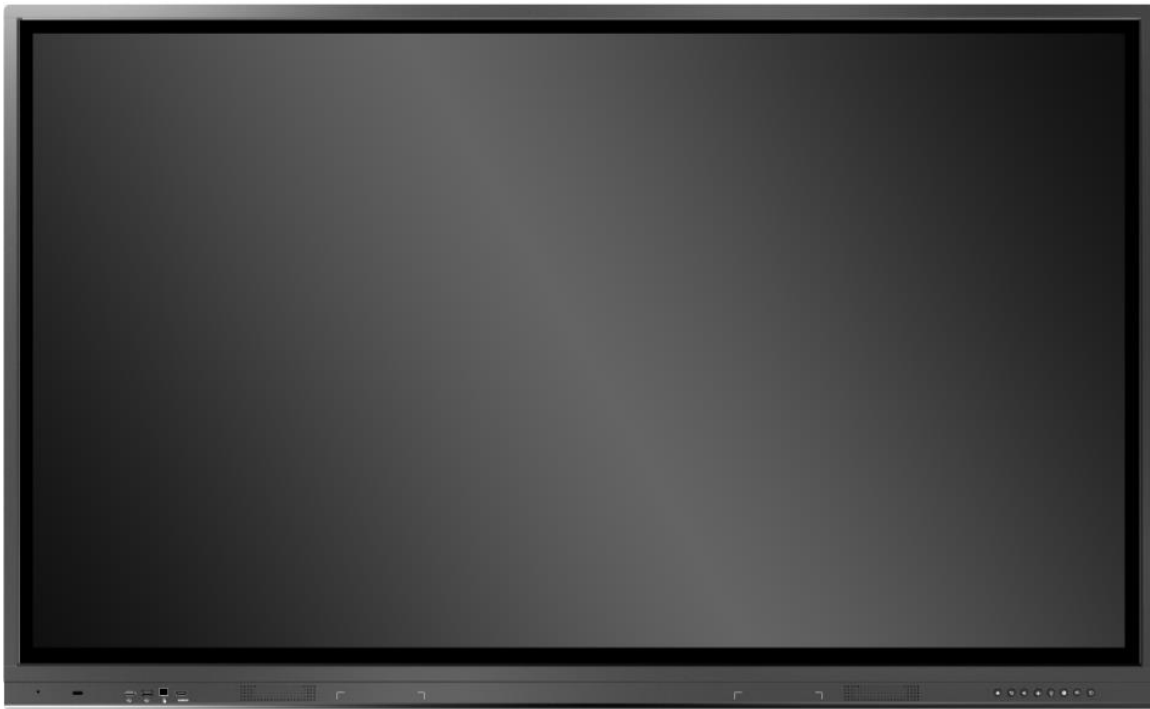

Content

Safety Instruction	1
Installation.....	3
Bearing	3
Wall-mounting.....	3
OPS Installation.....	5
Basic Operation	6
Power on.....	6
Power off	6
Control Panel.....	6
Panel Interface	7
Remote Control.....	9
Remote Control Area.....	11
Connecting and Setting.....	12
1. External Computer and Touch Connecting.....	12
2. AV Connecting.....	13
3. Video-OUT.....	13
4. RS232	14
Android Home Page	17
Bottom-up Toolbar	18
Signal Source Selection	19
Android Settings	20
Common Setting.....	20
Network Setting.....	21
Application Setting	22
Storage Setting	22
Date Setting.....	22
Language Setting	23
Factory Reset.....	23
About Device	23
Built-in PC Operation	24
Menu	25
Included Accessories	27
Troubleshooting	28

Safety Instruction

For your safety, please read the following instruction before you use the product. Serious injury or property loss may be caused by improper operations. Do not try to repair the product without guidance.

Placement

- Do not place the unit on an unstable cart, stand, tripod, racket, table, or shelf.
- Do not expose the unit to direct sunlight and other sources of heat.
- Do not handle liquids near or on the unit.
- Never spill liquid of any kind into the unit
- Do not put the unit near appliances that create magnetic fields.

Power Supply

- Check that the unit's operating voltage is identical with your local power supply.
- Please unplug power supply and aerial plug when the weather is thunder-storm or lighting.
- Please unplug power supply when there is nobody at home or didn't use over a long time.
- Please keep power cord from physical or mechanical damage.
- Please use exclusive power cord, don't modify or lengthen it.
- Please check and ensure AC source is connected with the ground.
- A sudden power failure may damage the panel.
- Frequent power on and off in a short time may cause faults.

LED Screen

- Never use any other tough or sharp object to replace the written pen.
- Unplug the power supply plug before cleaning.
- Clean the screen with a soft dustless and dry cloth.
- Never use water or the spray type detergent to clean the unit.
- For deep clean, contact an authorized service center.
- Please don't display the high brightness image on the screen for a long time.

Sight Distance

- The best distance between audience and screen is 5-7 times that of screen diagonal.
- The best watching angle between audience and screen is within 176 degrees.

Temperature

- Do not place the unit near or over a radiator or a heater register.
- If your unit is suddenly moved from a cold to a warm place, unplug the power cord for at least.
- Two hours so that moisture that may have formed inside the unit can dry completely.

- Normal operating temperature is 5 ~ 40°C.

Humidity

- Do not expose machine in rain, damp or place near water.
- Ensure the indoor drying, cool.

Ventilation

- Keep the ventilation openings clear.
- Ensure that the unit has enough space for ventilation around: left, right and back >10cm, top> 20cm.

Earphone

- It will affect the hearing if you listen to noisy sound for a long time.
- Before using earphone, please turn down the volume in advance.

CAUTION

- This is a Class A product. In a domestic environment, this product may cause radio interference in which case the user may be required to take adequate measures.

Installation

Bearing

If the product is installed in a wall-mounted way, the bearing capacity of the surface for installation must be at least four times of the weight of the product. If the surface for installation is a wall or the ceiling of a building, the surface must be made of solid bricks, concrete or other materials with equal intensity. If the product is installed on a surface made of loose material such as an old brick wall, wood plank wall, solid brick wall, a metal or non-metal structure surface, or a surface with a thick decoration layer, take necessary consolidating measures to ensure that the product is stably installed.

Note: When the product is installed in a wall-mounted way, the screws need to be installed deeper than 10 mm in the wall. Do not block ventilation vents.

Wall-mounting

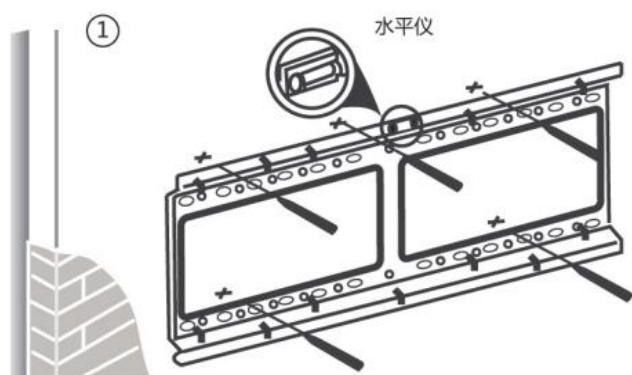

Use a level to locate the holes in a horizontal line and mark with pencil where the holes will be located. Then drill holes in the wall.

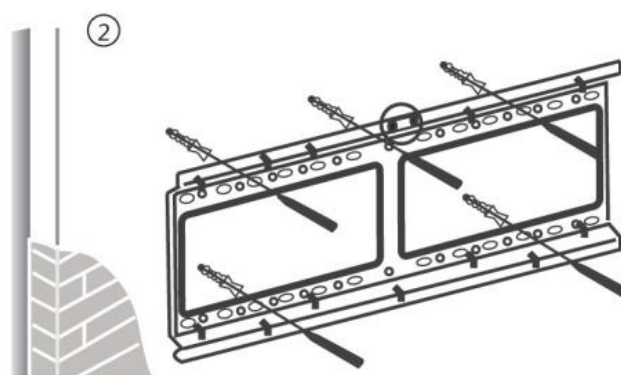

Insert wall plugs into the mounting holes
Insert wall plugs into the mounting holes.
Push the self-tapping screws through the bracket into the wall plugs and tighten the screws.

Hang the screen and let it settle into the bracket. Ensure that it is firmly in place.

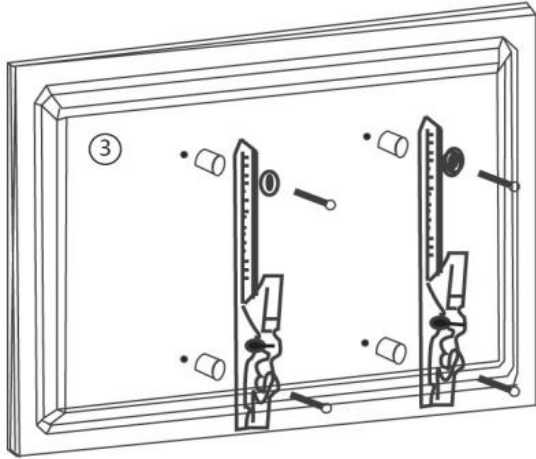

Attach the mounting arms to the back of screen with the screws.

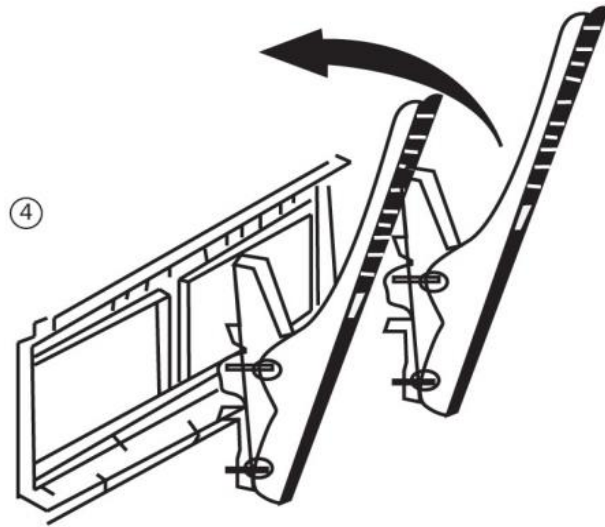

Insert wall plugs into the mounting holes. Push the self-tapping screws through the bracket into the wall plugs and tighten the screws.

Note: The horizontal and vertical distance of mounting holes on the back of screen must be within the required distance of bracket.

OPS Installation

Note: The OPS does not support hot-plugging. Please insert the plug of the OPS after the interactive panel is disconnected from the power.

Install the OPS by the following steps:

1. Insert the OPS into the special slot on the rear of the interactive panel.
2. Tighten the screws.
3. Confirm that the OPS is installed correctly.



Basic Operation

Power on









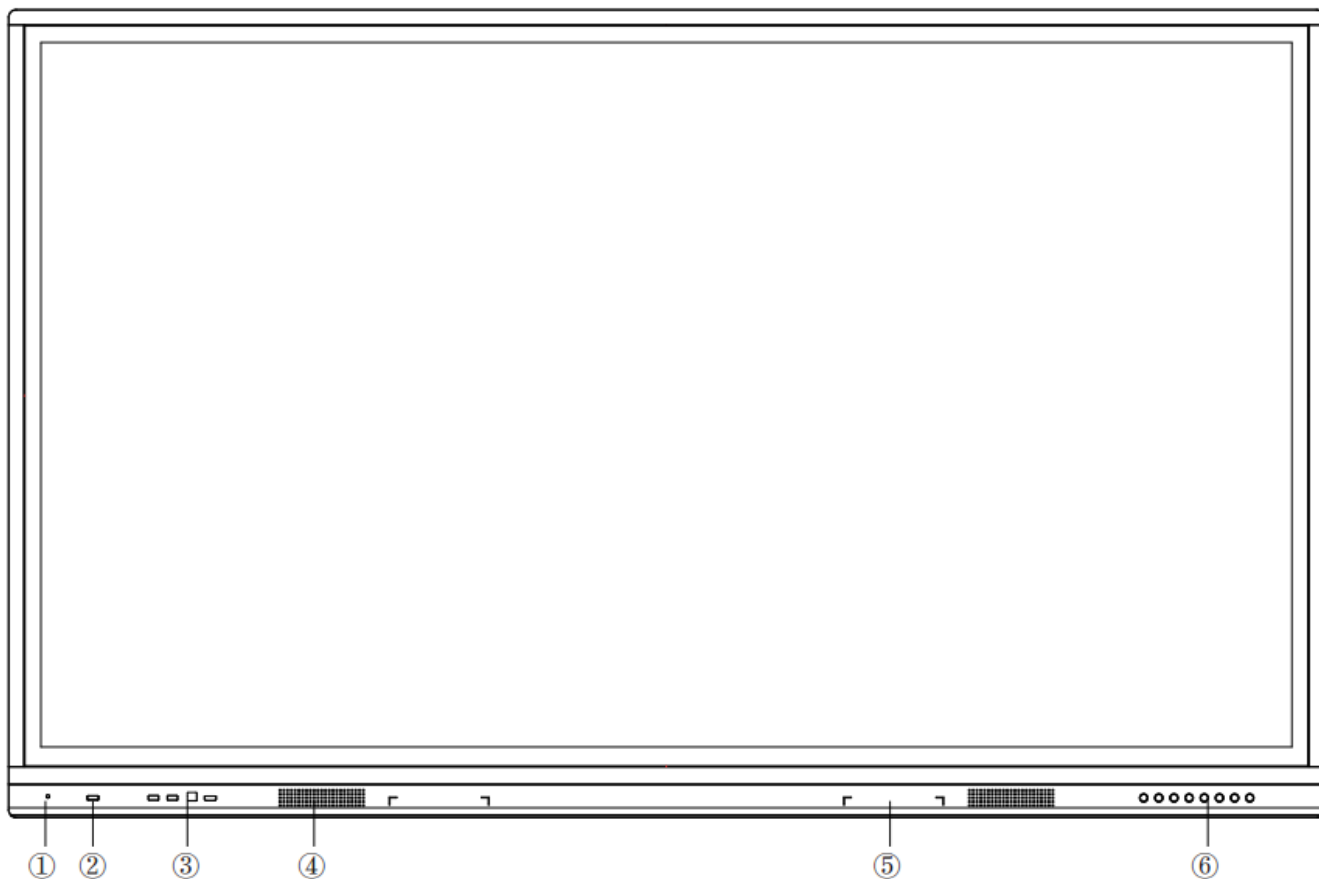

- Power the interactive touch screen with the 100V-240V 50Hz/60Hz AC power supply.
- Connect the panel to the power supply. Press the rocker switch (on the bottom left in the rear of the panel) to enter standby mode. The power indicator turns red.
- Press power button on the control panel or Power button on the remote control to turn on the display and built-in PC simultaneously. The power indicator turns green.

Power off

- Press **ECO** on the control panel to temporarily turn off the display.
- Press power button on the control panel or Power button on the remote control to enter standby mode. The power indicator turns red.
- In standby mode, press the rocker switch to power off the touch screen.

Control Panel



Item	Icon	Function Description
1	-	Brightness sensor: Auto adjust brightness according to the enviroment
2	-	Remote control receiving module
3		Android/PC USB port*2 auto switch (Do not switch the signal source if the usb flash drive is writing.)
		Touch Port, designated for Front HDMI port
		HDMI port used to connect an external display device
4	-	Front Speakers
5	-	Magnetic pen holder
6		Enter/Return to Android home page
		Return to previous interface
		Decrease volume
		Increase volume
		Enter ECO mode to turn off the display
		Enter/Exit Setting menu
		Enter/Exit signal source menu
		Power button: On or standby mode



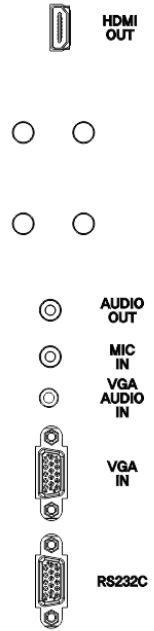
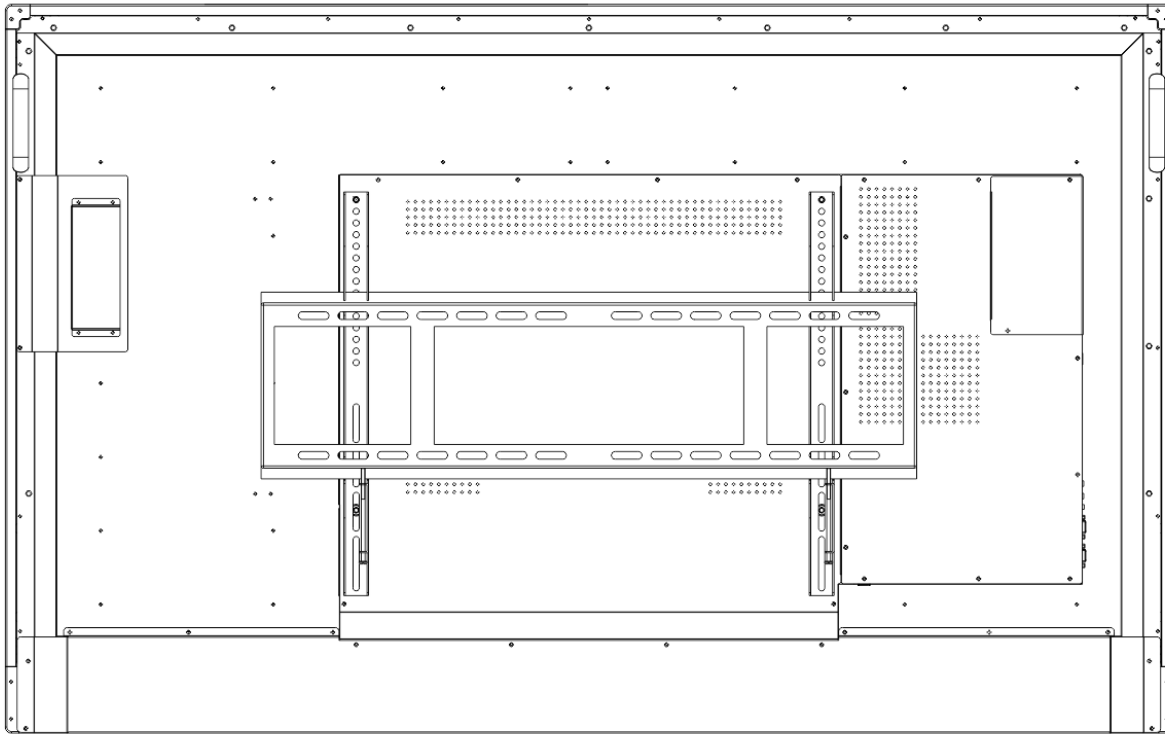

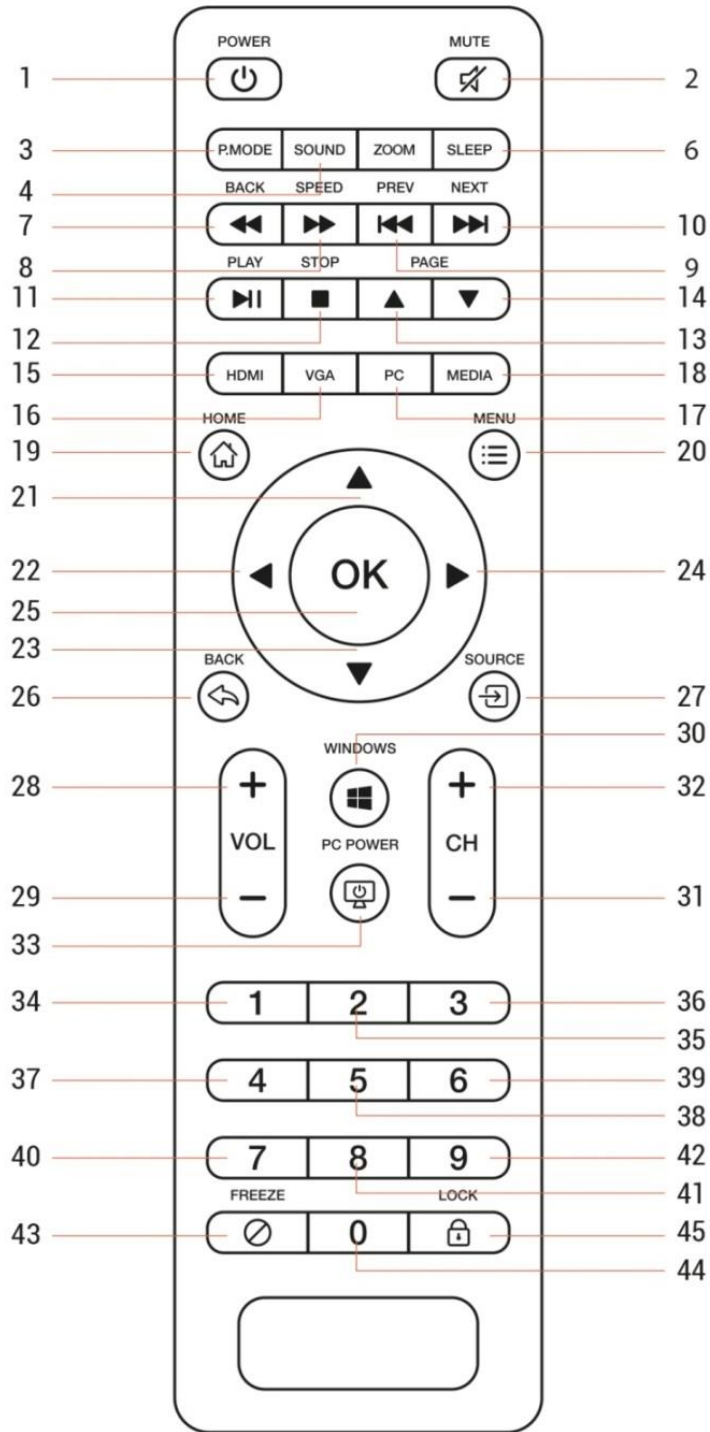

Panel Interface



Remote Control



Remote Control Buttons Function Description

1	POWER	Power supply switch, Turn on and off the AC power
2	MUTE	Mute ON/OFF for the sound
3	P-Mode	Press Button to open Menu Picture Mode page
4	Sound	Press Button to open Menu Sound Mode page
5	Zoom	In USB Mode, Press button to Enlarge picture size
6	Sleep	Activate the sleep function
7		Fast reverse
8		Fast forward
9		Previous track
10		Next track
11		Play/Pause
12		Stop the current playback
13	Page ▲	Enter to Menu upper line
14	Page ▼	Enter to Menu lower line
15	HDMI	Press button switching to HDMI inputs
16	VGA	Press button switching to VGA inputs
17	PC	Switching to OPS
18	Media	Switching to Media signal
19	Menu	Invalid button (Current Model w/No function)
20	Exit	Press button to enter Menu Table
21	▲	Direction button, press to move up
22	◀	Direction button, press to move left
23	▼	Direction button, press to move right
24	▶	Direction button, press to move down
25	Enter	Press button to enter select item
26	Back	Press button return to previous page
27	Source	Source input signal selection (switching Source Menu one by one)
28	VOL+	Sound Volume Up, Push button to increase Volume
29	VOL-	Sound Volume down, Push button to decrease Volume
30	Windows	Switching to OPS
31	Button-	Press to move down
32	Button +	Press to move up
33	PC Power	PC Power Switch
34	1	Number Button of 1 (Current model, all number button only used for factory menu setup, if necessary please consult to sale agency)
35	2	Number Button of 2
36	3	Number Button of 3
37	4	Number Button of 4
38	5	Number Button of 5
39	6	Number Button of 6
40	7	Number Button of 7
41	8	Number Button of 8
42	9	Number Button of 9
43		Freeze moving picture to a state image (Current Model w/No function)
44	0	Number Button of 0
45		Children Lock Function (Current Model w/No function)

NOTE: Functions related to PC will only work if internal PC is installed.

Remote Control Area

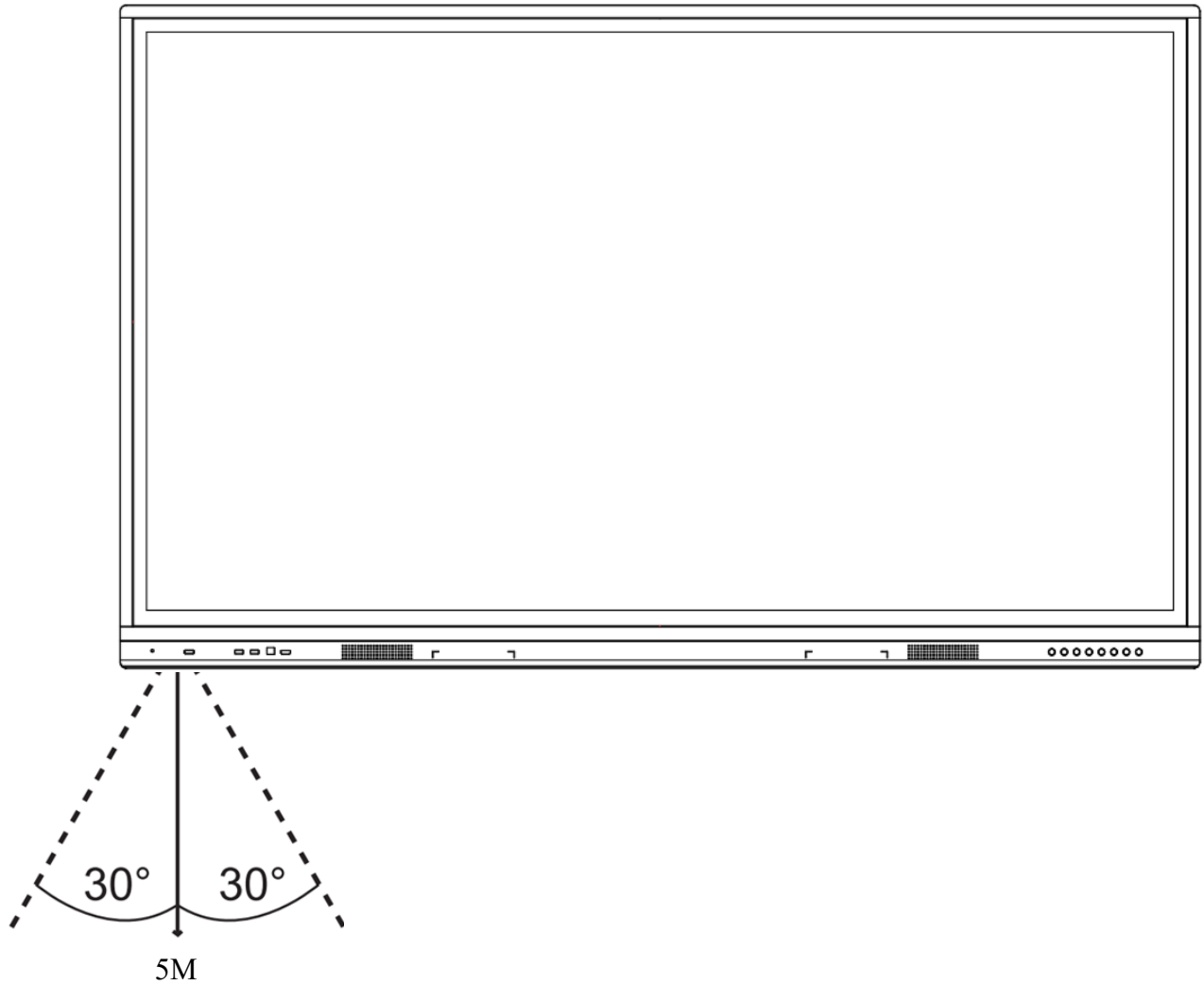



The effective receiving area is about 3 meters with 30° angle from vertical point to the left and right. And the effective receiving area is about 5 meters from the front of device. Note that the remote control signal receiver locates at the position of power indicator.

Connecting and Setting

For safety, please do not connect any power supply before the external devices setup.

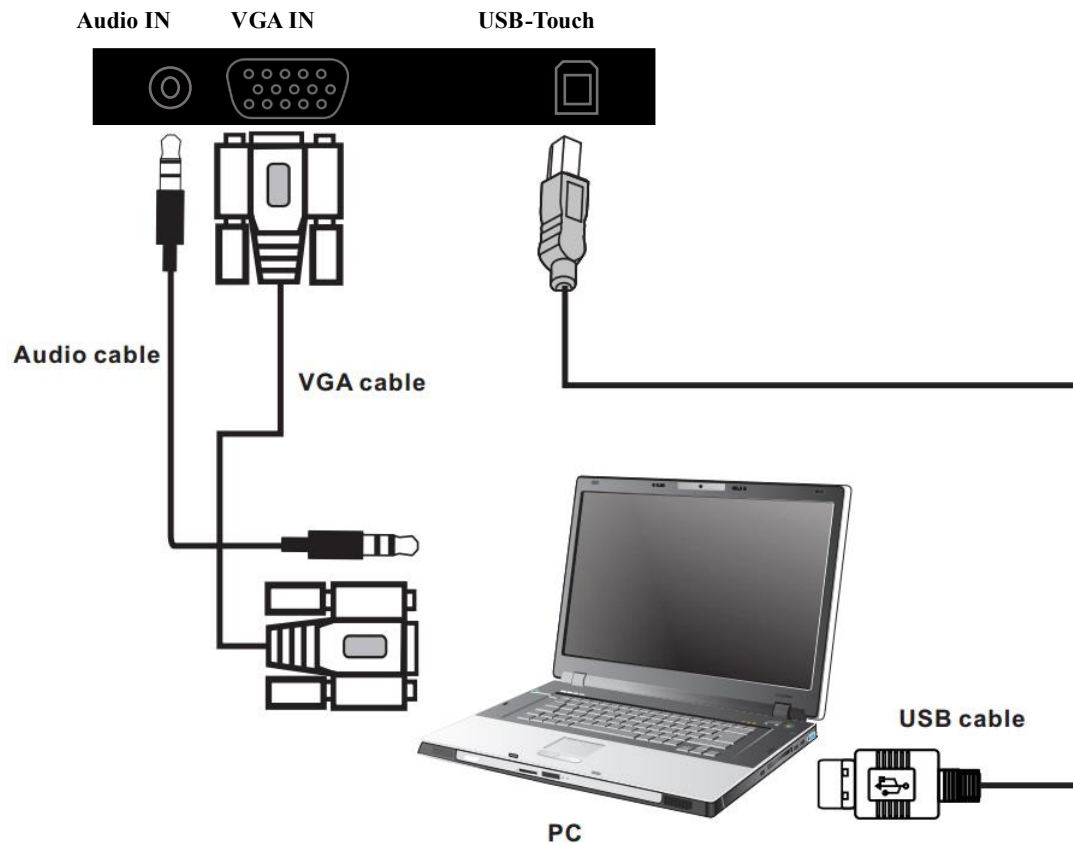
1. External Computer and Touch Connecting



- 1) Connect a VGA cable (15 pin) between the VGA and external PC. Connect an earphone cable between the PC and audio at the same time.
- 2) Connect a USB cable between the external PC and USB terminal.
- 3) Plug the POWER cord and switch it on from the rear panel.
- 4) Start up the external computer.
- 5) Press  to turn on the panel.
- 6) Select Signal source to VGA source according to the one you connected.

Note: The panel can connect with the external PC via HDMI.

2. AV Connecting

● HDMI IN

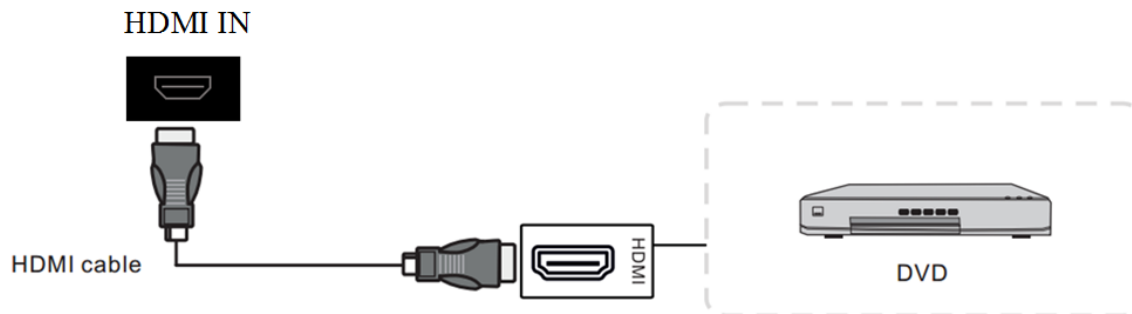

- 1) Connect a HDMI cable with the device with HDMI.
- 2) Plug the POWER cord and switch it on from the rear panel.
- 3) Press \cup to turn on the panel.
- 4) Select Signal source to HDMI source according to the one you connected.

3. Video-OUT

● HDMI-out

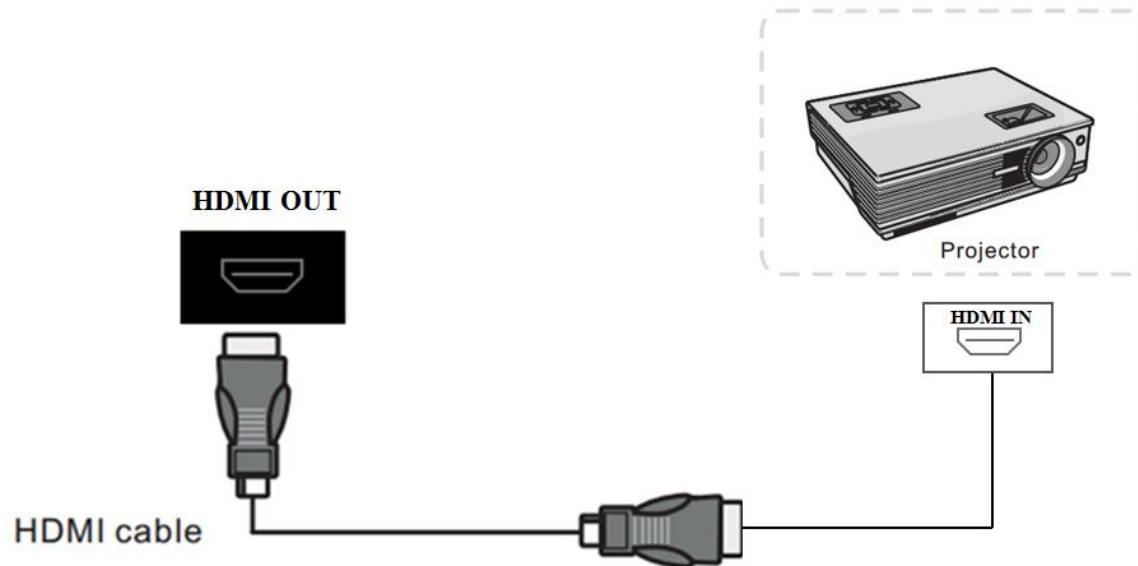

- 1) Connect a HDMI cable with the device with HDMI.
- 2) Plug the POWER cord and switch it on from the rear panel.
- 3) Press \cup to turn on the panel.

4. RS232

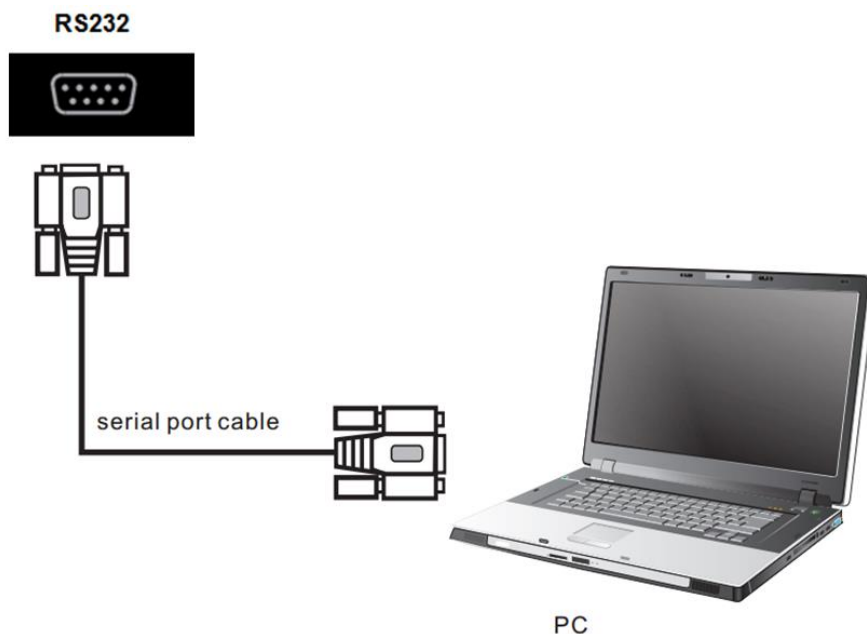

- 1) Connect a serial port cable with the device.
- 2) Plug the POWER cord and switch it on from the rear panel.
- 3) After connecting the central control system and unit, you can use some of the function such as power on/off or adjust the volume etc.

RS232 code list

Baud rate: 38400bps Stop bit: 1 bit Data bits: 8 bit Odd-even check: none Communication encoding: Hex code	
Function	Required Commands(Hex)
Power	55 00 8E 00 E3
SOURCE	55 00 80 00 D5
Up	55 00 00 01 56
Down	55 00 00 02 57
Left	55 00 00 03 58
Right	55 00 00 04 59
OK	55 00 00 00 55
Menu	55 00 14 00 69
Exit	55 00 16 00 6B
Info	55 00 18 00 6D
Mute	55 00 1A 00 6F
Favorite	55 00 1E 00 73
Sleep Mode	55 00 20 00 75

Sound Mode	55 00 22 00 77
Picture mode	55 00 28 00 7D
Set Sleep Timer	55 00 4A 00 9F
Aspect	55 00 4C 00 A1
Volume plus(+)	55 00 0C 00 61
Volume plus(-)	55 00 0E 00 63
Channel plus(+)	55 00 10 00 65
Channel plus(-)	55 00 12 00 67
Return	55 00 0A 00 5F
Auto Scan	55 00 58 00 AD
Switch to DTV	55 00 80 01 D6
Switch to ATV	55 00 80 02 D7
Switch to Scart	55 00 80 03 D8
Switch to YPBPR	55 00 80 04 D9
Switch to YPBPR 2	55 00 80 10 E5
Switch to VGA 1	55 00 80 05 DA
Switch to VGA 2	55 00 80 06 DB
Switch to VGA 3	55 00 80 07 DC
Switch to HDMI 1	55 00 80 08 DD
Switch to HDMI 2	55 00 80 09 DE
Switch to HDMI 3	55 00 80 11 E6
Switch to HDMI 4	55 00 80 12 E7
Switch to HDMI 5	55 00 80 13 E8
Switch to HDMI 6	55 00 80 14 E9
Switch to DP	55 00 80 15 EA
Switch to OPS	55 00 80 0B E0
Switch to front HDMI	55 00 80 0A DF
Switch to AV 1	55 00 80 0C E1
Switch to AV 2	55 00 80 0D E2
Switch to SV	55 00 80 0E E3
Switch to USB	55 00 80 0F E4
Set Contrast	55 00 2A 00 7F
Set Brightness	55 00 2C 00 81
Set Saturation	55 00 2E 00 83

Set HUE	55 00 30 00 85
Set Sharpness	55 00 32 00 87
Set Color Temp	55 00 34 00 89
Set Reduction noise	55 00 36 00 8B
Set BASS	55 00 3A 00 8F
Set Treble	55 00 3C 00 91
Set Balance	55 00 3E 00 93
Set Language(0,1,2,3,,,))	55 00 42 00 97
Enter factory Menu	55 00 82 00 D7
Factory Reset	55 00 84 00 D9
Burning	55 00 86 00 DB
Backlight mode	55 00 88 00 DD
Screen shot	55 00 8A 00 DF
VGA auto adjust	55 00 8C 00 E1
Home	55 00 91 00 E6
WhiteBoard	55 00 93 00 E8
Resolution switch	55 00 95 00 EA
Audio Only	55 00 97 00 EC
Freeze	55 00 98 00 ED
Child lock	55 00 99 00 EE

Android Home Page

Journey 14 goes with completely new Android Interface for customization and quick-access.

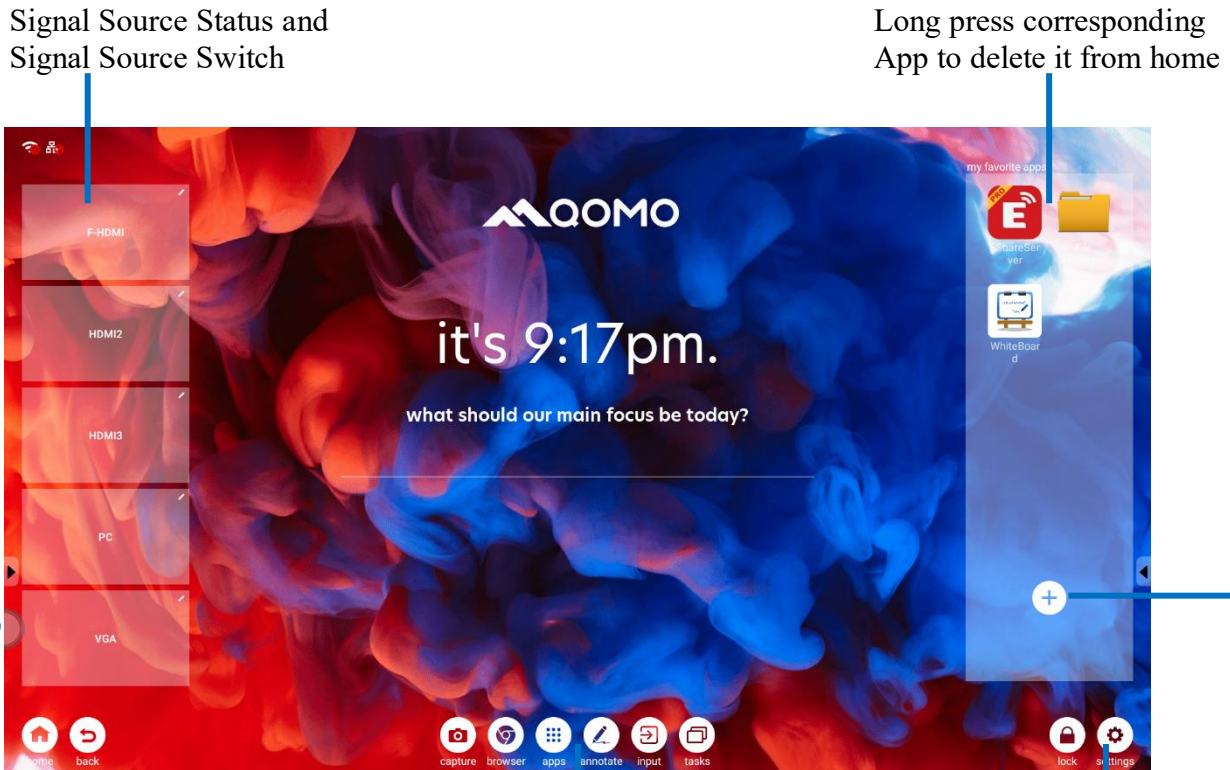

The side menu
System Help

Long press corresponding
App to delete it from home

Add frequently-
used apps on
the home screen

Capture: Screen Shot.
Browser: Built-in browser.
Application: Click to access more applications interface.
Annotate : Click to enable annotation software.
Input: Source Selection.
Tasks: open task column Ending task.

Lock: Lock screen
Settings: Click to enter the Android settings interface.



Tap the circle to move or hide it.

Click the center of System Help to unfold 5 shortcuts.

- **Home:** Return to Android home page.
- **Mem Clear:** Clear memory to speed up memory.
- **Check:** Click to check system status like Network status, OPS status, touch status and etc.
- **A-Lock:** Set password for apps. User only enters password to enable the app.
- **S-Lock:** Lock screen.

Bottom-up Toolbar





The toolbar can be invoked in any signal source interface. Swipe up from the bottom of screen and it will appear.

Buttons	Functions
	Return to Android home page
	Return to previous interface
	Screen Shot
	Built-in browser
	All applications interface
	Quick to annotate
	Change signal source channel
	Switch or end the running programs
	Lock screen
	Click to enter Menu

Signal Source Selection

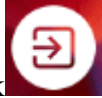
There are three ways to select a signal source to display.

- Swipe your finger up from the bottom edge to bring up a toolbar then click .
- Press **SOURCE** button on the remote control.
- Press  button on the front control panel.

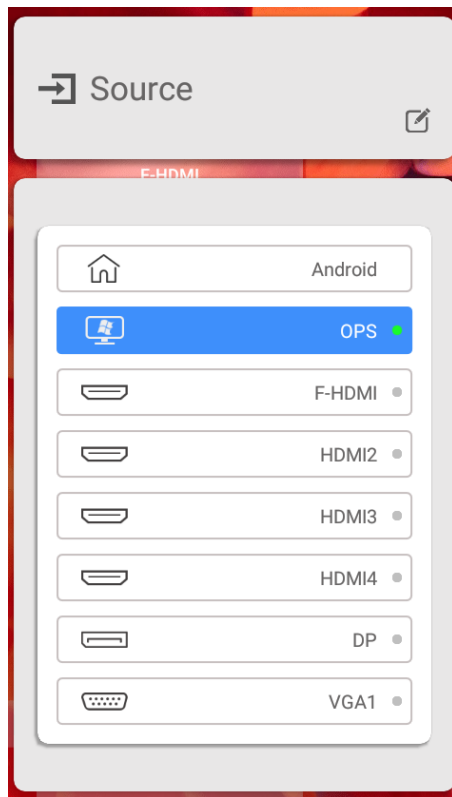

Green light indicates there's a signal and grey indicates no signal.

Signal Source Interface Select a source and press OK or click the channel icon directly to enter it.

Android Settings

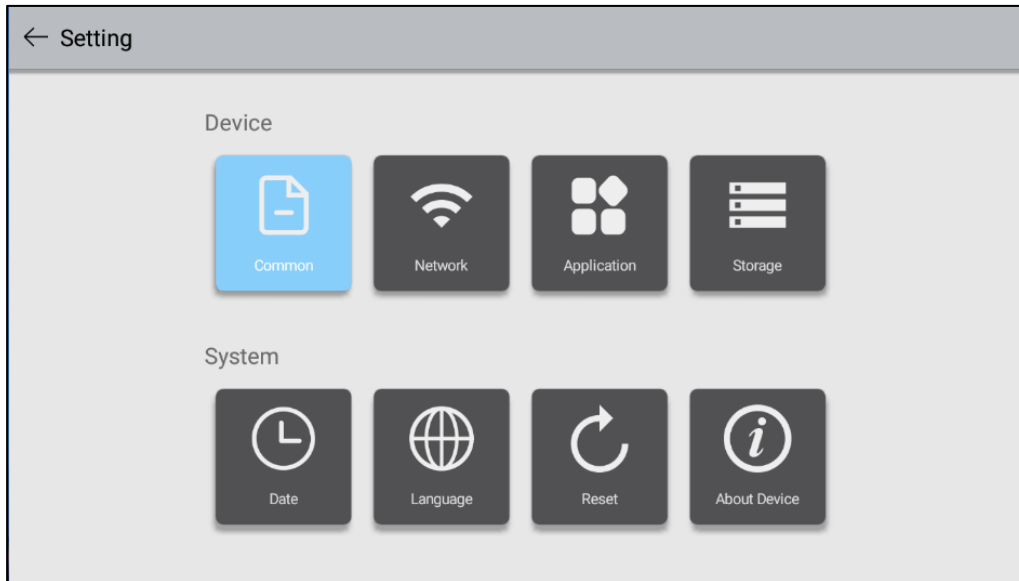

Common Setting

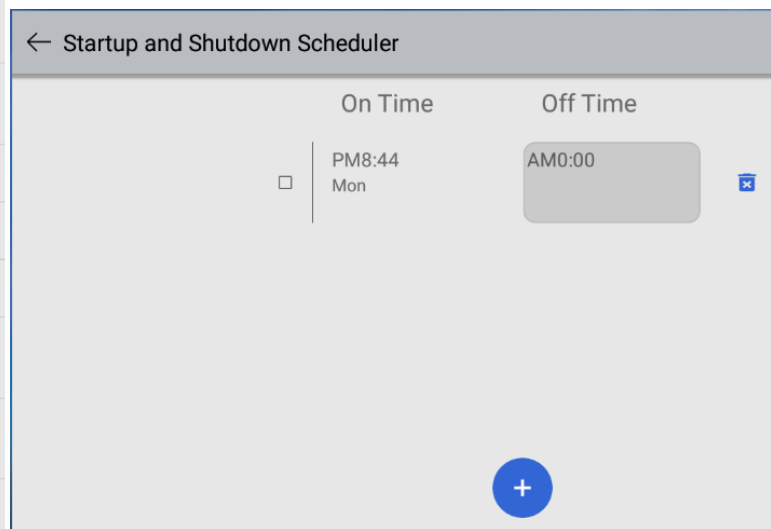
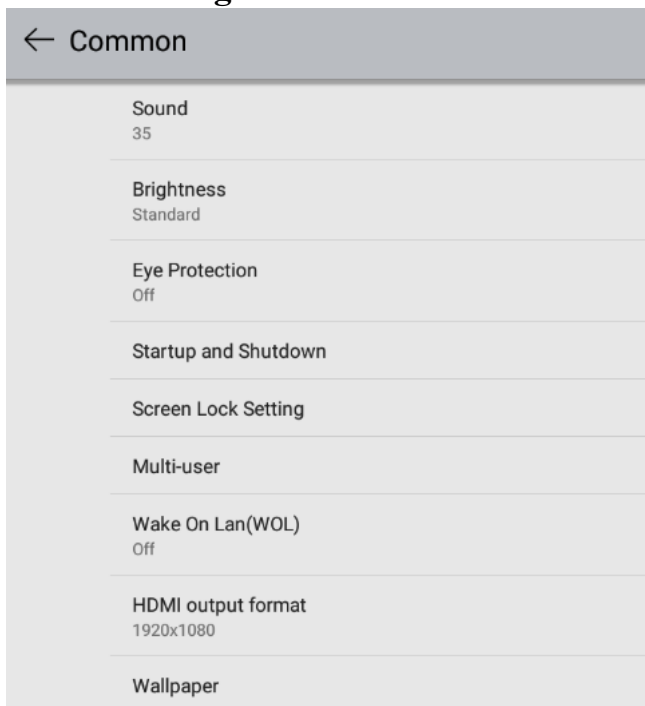

Click setting icon  on toolbar to enter Android setting interface.

Common function: Click Common function to set Sound, Brightness, Eye Protection, Startup and Shutdown, Screen Lock setting, Multi-user, Wake On Lan (WOL), HDMI output format, Wallpaper and Screen Saver.

- **Sound:** Slide right or left to increase or decrease the volume.
- **Brightness:** Slide to adjust the brightness.

- **Eye Protection:** Enable eye protection function. Brightness turns dim when you touch the screen for 0.5s and return to the previous status when your finger removes from the screen for 3s.
- **Startup and Shutdown:** Click  to set on/off time.
- **Screen Lock Setting:** Set the lock screen mode and one-key lock screen.
- **HDMI output format:** Set HDMI output to be 1920*1080 or 3840 * 2160.
- **Wallpaper:** Set dynamic or static wallpaper.
- **Screen Saver:** Set screen saver.

Multi-user Account Setting:

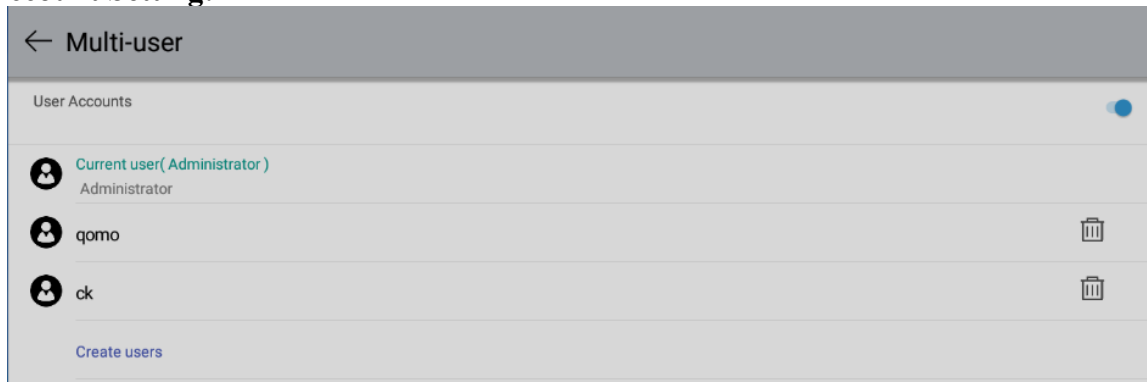

Journey 14 provides Multi-user Account Switch functions. It allows users to install their own apps in their own accounts.

Click Setting - Multi-user – Create users to create a new account as shown as above. Click corresponding account to enter it or click delete icon to remove the account.

Network Setting

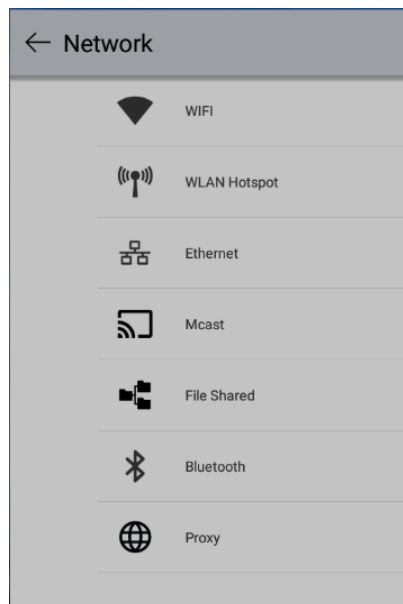

Network: Set WIFI, WLAN Hotspot, Ethernet, Bluetooth, Mcast, Proxy and etc.

Application Setting

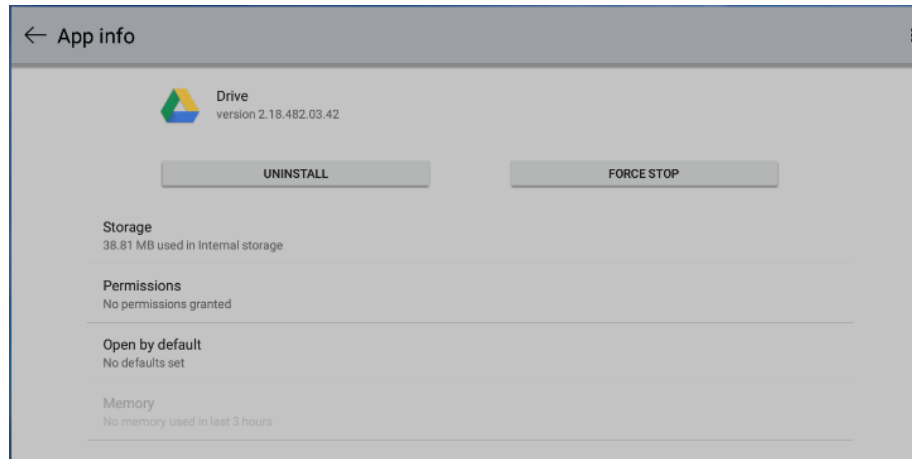

Application: Select corresponding apps to uninstall it. Note that you can't uninstall apps burnt-into the firmware.

Storage Setting

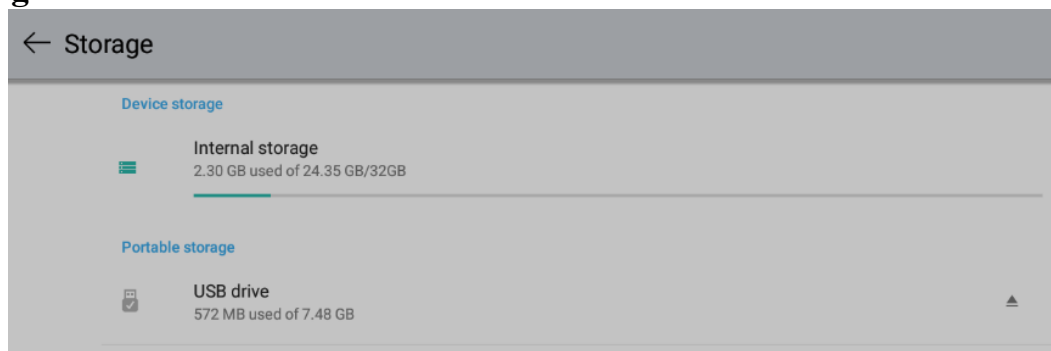

Click **Storage** to check internal storage and USB storage. Click eject icon  to safely remove the USB flash drive.

Date Setting

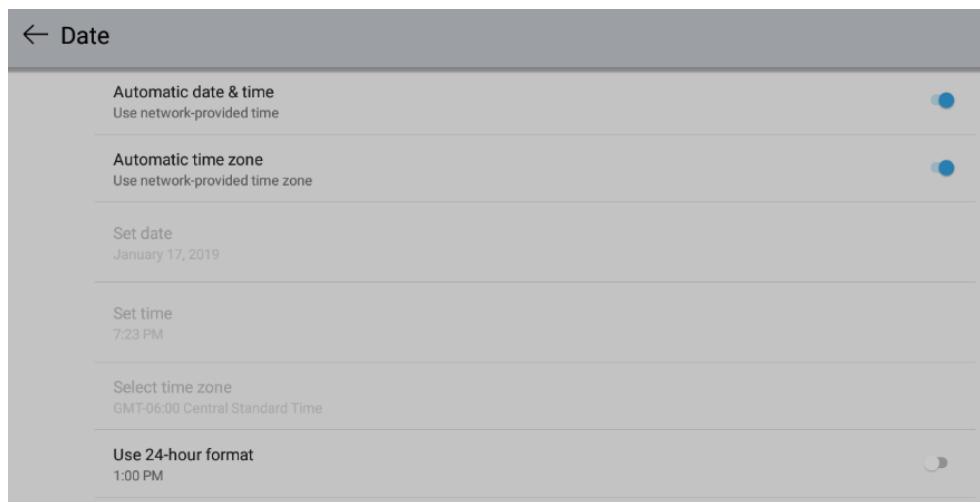

Date: Where you can change time format, time zone and etc.

Language Setting

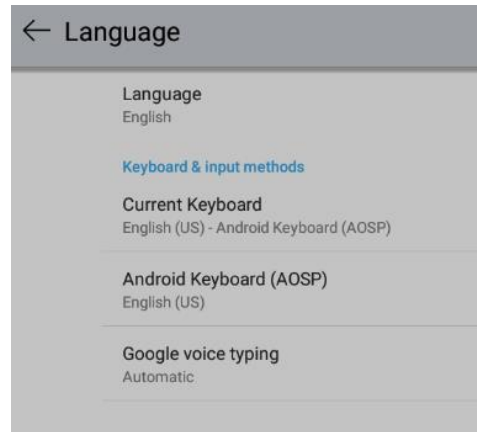

Language: Where you can change the system or keyboard language.

Factory Reset

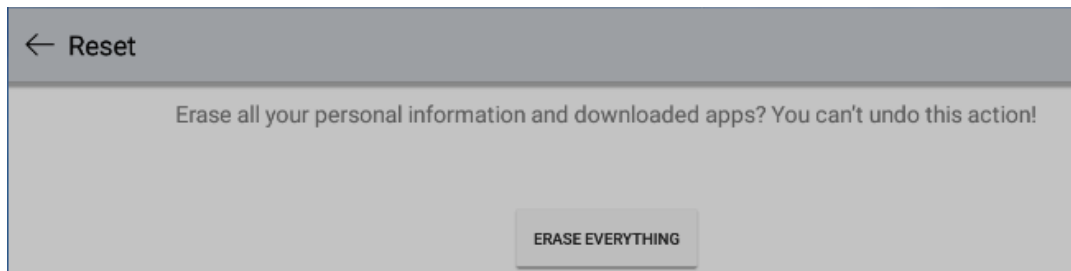

Reset: Erase all information and downloaded apps. You can't recover it.

About Device

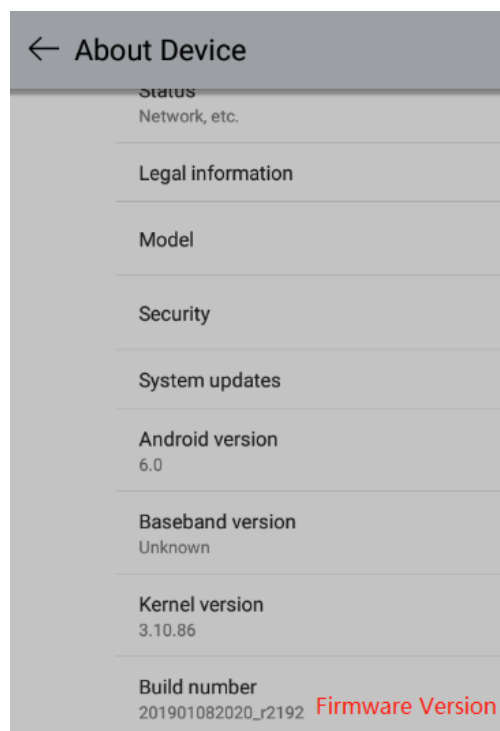

About Device: Where you can check Android Firmware Version “Build number”.

Built-in PC Operation

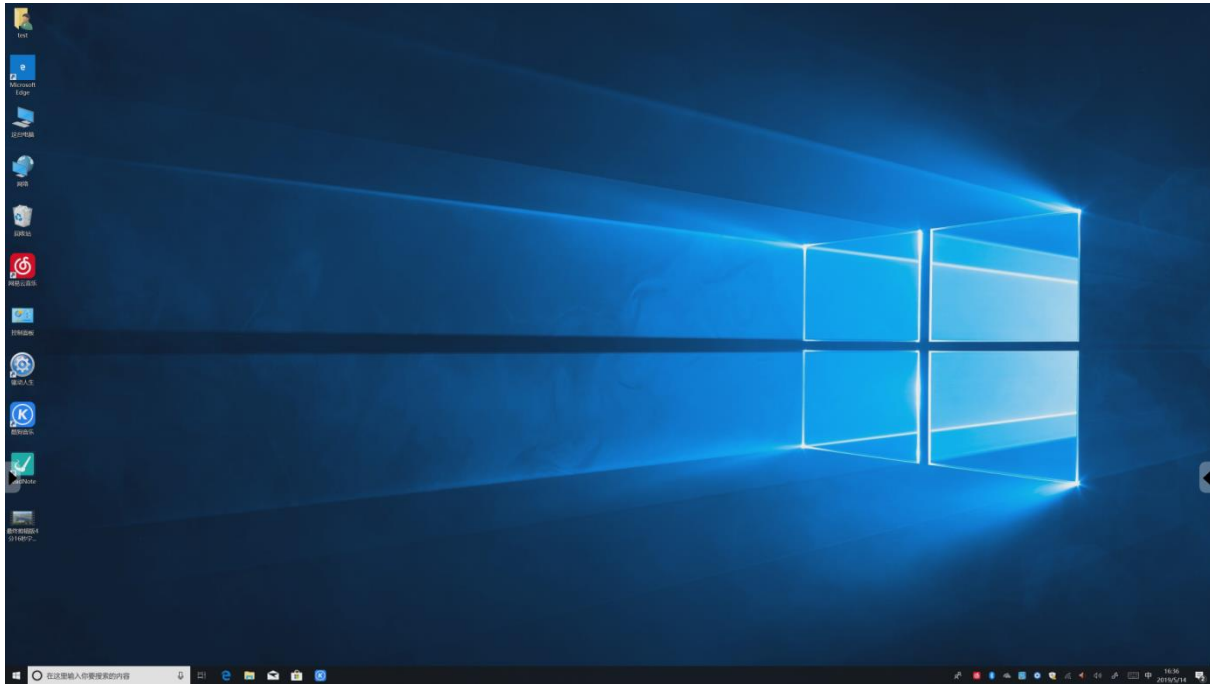

1. Select PC signal source to enter PC interface. The following are three ways to select a signal source channel.
 - Swipe your finger up from the bottom edge to bring up a toolbar then click **input**.
 - Press **SOURCE** button on the remote control.
 - Press  button on the front control panel.

In the signal source page, select a channel and press OK or click the channel icon directly to enter it.

2. Operate the built-in PC in the same way as you operate an ordinary computer.
3. Shut down PC before you turn off the panel. Do not power off a running PC suddenly to avoid data lose. Or you could also press Power button to turn off PC and panel at the same time.

Menu

Click menu icon  on the bottom-up toolbar. Menu pops up as follows. Under menu, you can set sound and etc. Here provides some for quick-access.

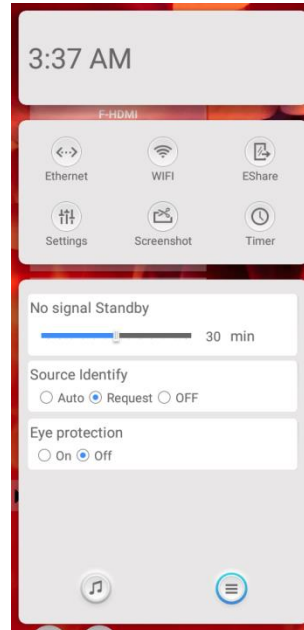
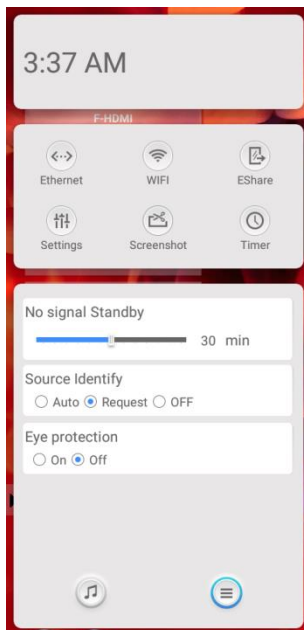
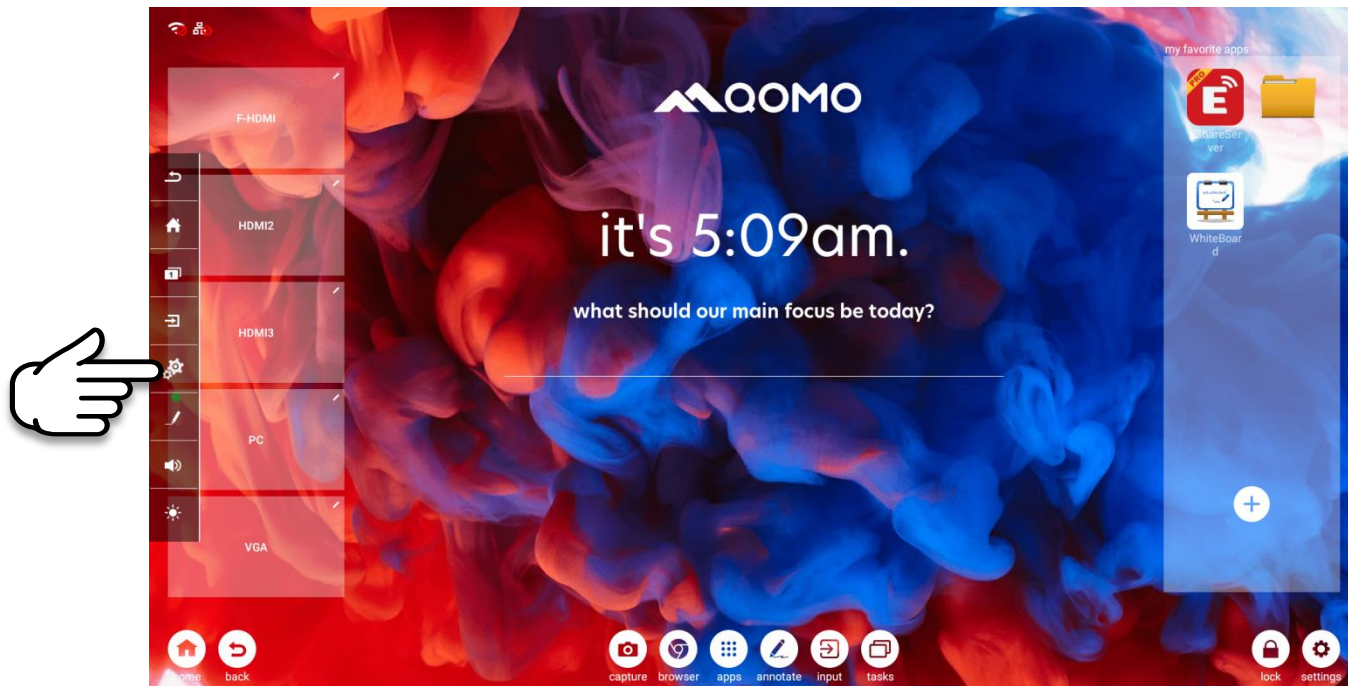

Whiteboard Annotation



White board is an annotation software pre installed in the Journey panels. It features high speed annotation without any delay.

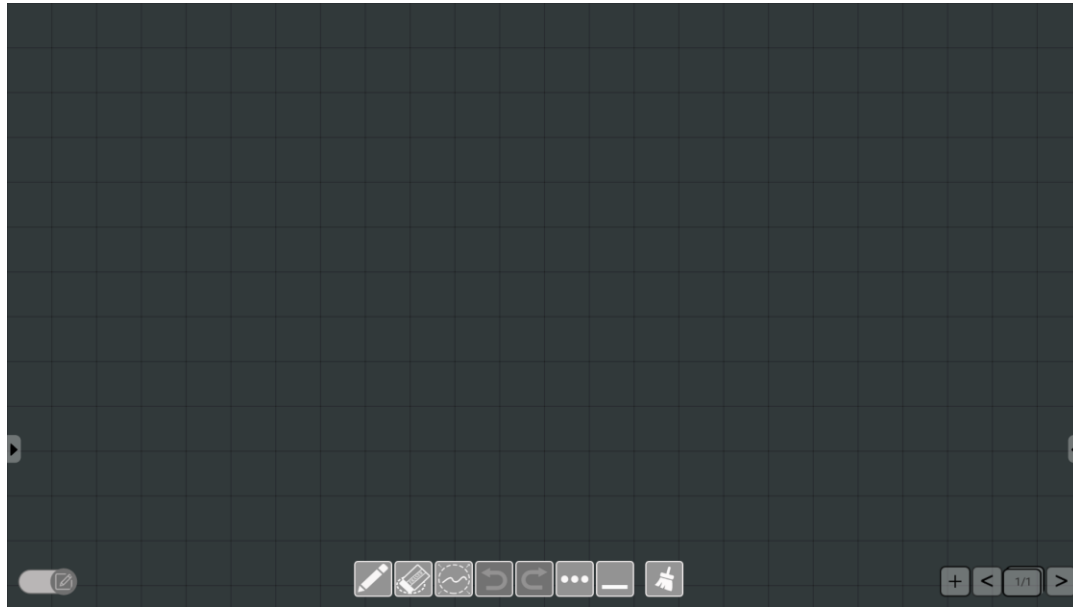

Whiteboard Main Interface

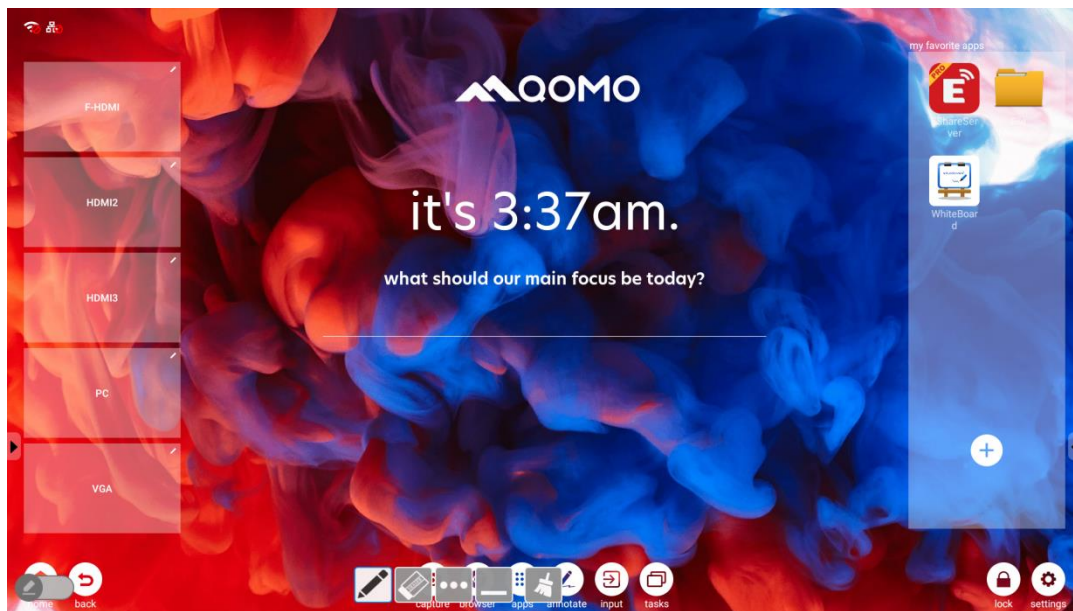











Whiteboard Desktop Mode

Switch between whiteboard main interface and desktop mode

Pen Eraser Select Undo Redo More Hide Clear

Slide Management

Included Accessories

Picture	Name	Quantity
	Remote control	*1
	Magnetic Pen	*2
	Pointer	*1
	Power cable	*1
	HDMI cable	*1
	USB cable (A-B)	*1
	Bracket	*1
	WIFI Antenna	*4
	Warranty card	*1
	CD	*1

Troubleshooting

Remote Control	
Remote control out of order	<ul style="list-style-type: none"> ● Check whether there is object between remote control and panel receiver; ● Check whether the battery is installed correctly; ● Check whether the battery is drained.
Touch	
Touch does not response.	<ul style="list-style-type: none"> ● Make sure infrared frames have not been obscured. ● Check whether you enable freeze function on remote control.
Built-in PC	
OPS shut down automatically.	<ul style="list-style-type: none"> ● Check if OPS is properly installed; ● Sleeping mode setting;
Handwriting	
Part of the handwriting cannot be displayed.	<ul style="list-style-type: none"> ● Use the pen rather than a finger to write. Hold the pen as far to the nib as possible. The angle between the pen and display needs to be greater than 60 degrees. Do not touch the display with your sleeve or wrist. ● Change the nib or use a pen with larger covering area. ● Check if infrared frames are obscured. ● Remove the interference source or change the using environment.
No display or no sound	
No sound is played and no image is displayed.	<ul style="list-style-type: none"> ● Check whether the power plug is inserted into the power socket and whether the panel is powered on. ● Check whether the rocker switch on the interactive panel is switched on. ● Check whether panel is in ECO mode. ● Check whether the video and audio input cables are connected correctly. ● Check whether the panel is switched to the right signal source. ● Check the settings on image brightness and contrast. ● Check the volume.
Image is displayed properly, but no sound is played.	<ul style="list-style-type: none"> ● Check the volume. ● Check whether the Mute button on the remote control is pressed. ● Check whether the audio cable between the PC and interactive panel is connected correctly.
No image is displayed or the image is black and white.	<ul style="list-style-type: none"> ● Modify the color settings. ● Check the color system.

This is the general user manual for all QOMO interactive touch screens. Some details may be different from the actual product.