

# Interactive Touch Screen User Manual



Please properly keep the manual for further reference. This is the general user manual for all interactive touch screens. Therefore, it may be different from the actual product.

Welcome:

Thanks for purchasing this product. Please read the instructions carefully before using this product.

---

This device complies with part 15 of the FCC Rules. Operation is subject to the following two conditions:

- (1) This device may not cause harmful interference, and
- (2) This device must accept any interference received, including interference that may cause undesired operation.

This equipment has been tested and found to comply with the limits for a Class B digital device, pursuant to part 15 of the FCC Rules. These limits are designed to provide reasonable protection against harmful interference in a residential installation. This equipment generates, uses and can radiate radio frequency energy and, if not installed and used in accordance with the instructions, may cause harmful interference to radio communications. However, there is no guarantee that interference will not occur in a particular installation. If this equipment does cause harmful interference to radio or television reception, which can be determined by turning the equipment off and on, the user is encouraged to try to correct the interference by one or more of the following measures:

- Reorient or relocate the receiving antenna.
  - Increase the separation between the equipment and receiver.
  - Connect the equipment into an outlet on a circuit different from that to which the receiver is connected.
  - Consult the dealer or an experienced radio/ TV technician for help.
- 

The symbol of the crossed out wheeled bin indicates this product should not be placed in municipal waste. Instead, you need to dispose of the waste equipment by handing it over to a designated collection point for the recycling of waste electrical and electronic equipment.

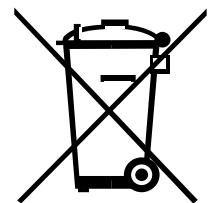









# Content





<b>Safety Instruction</b> .....	1
<b>Installation</b> .....	3
<b>Introduction</b> .....	6
<b>Basic Operation</b> .....	7
Power on .....	7
Power off.....	7
OPS Installation .....	8
<b>Remote Control</b> .....	9
Functions of remote control.....	9
Instructions of remote control.....	10
<b>Buttons &amp; Ports</b> .....	11
Buttons & ports on the front panel.....	11
Ports on the rear panel for 65” & 75” .....	12
Ports on the rear panel for 86” .....	12
RS232 code list.....	13
<b>Operation Interface</b> .....	17
Android Home Page.....	17
Android Settings .....	19
Built-in PC Interface.....	25
Other Source Settings .....	25
Bottom-up Toolbar.....	26
Annotation software - MagicBoard .....	27
<b>Included Accessories</b> .....	31
<b>Troubleshooting</b> .....	32



## Safety Instruction

For your safety, please read the following instruction before you use the product. Serious injury or property loss may be caused by improper operations. Do not try to repair the product by your own.

 <b>WARNING</b>	
	<p><b>Disconnect the product from power supply immediately if major failures occur.</b></p> <p>The major failures include the following:</p> <ul style="list-style-type: none"> <li>• Smoke, peculiar smell or abnormal sound is discharged from the product.</li> <li>• No image or sound is displayed, or the image error occurs.</li> <li>• Where the mains plug or an appliance coupler is used as the disconnect device, such disconnect device shall remain readily operable.</li> </ul> <p>In the preceding scenarios, do not continue to use the product, disconnect power supply immediately and contact professional staff for troubleshooting.</p>
	<p><b>Do not drop liquid, metal or combustible into the product.</b></p> <ul style="list-style-type: none"> <li>• If any liquid or metal is dropped into the product, power off the product and disconnect power supply, then contact professional staff for solutions.</li> <li>• Pay attention to the children when they are close to the product.</li> </ul>
	<p><b>Do not damage the power cable.</b></p> <ul style="list-style-type: none"> <li>• Do not damage, change, wind, bend, heat or drag the power cable forcibly.</li> <li>• Do not put weights (such as the product itself) on the power cable.</li> <li>• Do not drag the cable forcibly when you pull out the power plug. If the power cable is damaged, please contact the local distributor to repair or replace it.</li> </ul>
	<p><b>Put the product on a stable surface.</b></p> <p>An unstable surface includes and does not limit to an inclined plane, a shaky stand, desk or platform, which might cause the turnover and damage.</p>
	<p><b>Use the battery correctly.</b></p> <ul style="list-style-type: none"> <li>• Galvanic corrosion, electric leakage and even fire may be caused by improper battery usage.</li> <li>• It is recommended to use the designated type of battery and install the battery by correct electrodes (positive and negative electrodes).</li> <li>• Do not install and use new battery with the used one.</li> <li>• Take out the battery if the remote control is not used for a long period.</li> <li>• Do not expose the battery under overheated environments such as sunlight and firing.</li> <li>• Dump the used battery based on local regulations.</li> </ul>
 <b>WARNING</b>	
	<p><b>Do not open the cover or change the product by your own.</b></p> <p>High voltage components are installed in the product. When you open the cover, high voltage, electric shock or other dangerous situations may occur. If inspection, adjustment or maintenance is required, contact the local distributor for help.</p>

	<p><b>Use the specified power supply.</b></p> <ul style="list-style-type: none"> <li>Do not use any types of power cables other than the one provided with the product to prevent the product from being damaged.</li> <li>Use a three-wire socket and ensure that it is properly grounded.</li> <li>Pull out the power plug from the socket if the product is not used for a long period.</li> </ul>
	<p><b>Before you move the product, disconnect all external connections and separate all toppling preventing devices.</b></p> <p>Move the product carefully to prevent it from being hit or squeezed, especially the screen, which may cause injury if broken.</p>
	<p><b>Clean the dust and metal on the power plug regularly.</b></p> <ul style="list-style-type: none"> <li>When you are cleaning, fire or electric shock may be caused if the product is powered on.</li> <li>Keep in mind to pull out the power plug before cleaning it by using a dried cloth.</li> </ul>
	<p><b>Do not put items on the top of the product.</b></p> <ul style="list-style-type: none"> <li>Do not put items, such as a container for liquid (a vase, flowerpot, cosmetics or liquid medicine), on the top of the product.</li> <li>If any water or liquid is spilled on the product, short circuit may occur and cause fire or electric shock.</li> <li>Do not tread on the product or hang any items on the product.</li> </ul>
	<p><b>Do not install the product in an improper place.</b></p> <ul style="list-style-type: none"> <li>Do not install the product in humid places, such as the bathroom, the shower room, the place near windows or outdoor environments where experience rain, snow or other harsh weather. The product installation is also required to avoid a place around by hot spring vapor. The preceding environments may cause faults or electric shock under extreme conditions.</li> <li>Do not put exposed fire source, such as an ignited candle, on the product.</li> </ul>
	<p><b>Pull out the power plug during thunderstorms.</b></p> <ul style="list-style-type: none"> <li>Do not touch the product when lighting to avoid electric shock.</li> <li>Install or place components which power supply voltage is high enough to cause personal injury in places out of the reach of children.</li> </ul>

 <b>WARNING</b>	
	<p><b>Do not cover or block up any vents on the product.</b></p> <ul style="list-style-type: none"> <li>The overheated components may cause fire, damage the product and shorten the service life.</li> <li>Do not put the venting surface of the product facedown.</li> <li>Do not put the venting surface of the product facedown.</li> <li>Do not use a cloth such as table cloth to cover the product.</li> </ul>
	<p><b>Do not touch the power cable with wet hands to avoid electric shock.</b></p>
 <b>CAUTION</b>	

	<p><b>Do not install the product in high temperature environments.</b></p> <ul style="list-style-type: none"> <li>• Do not install the product near heat source, such as the radiator, the heat reservoir, the stove or other heating devices.</li> <li>• Do not expose the product under sunlight, which may cause high temperature and subsequent faults in the product.</li> </ul>
	<p><b>For transport:</b></p> <ul style="list-style-type: none"> <li>• Pack the product for mobility or maintenance by using the cartons and cushioning material provided with the product.</li> <li>• Vertically move the product during transport. The screen or other components are easily broken if the product is moved by an improper way.</li> </ul>
	<p><b>Keep away from the product when you use a radio.</b></p> <p>The product design to prevent radio interference complies with the international EMI standard. However, the interference still exists and causes noise in the radio.</p> <ul style="list-style-type: none"> <li>• If noise occurs in the radio, try the following solutions.</li> <li>• Adjust the direction of the radio antenna to avoid the interference from the product.</li> <li>• Keep the radio away from the product.</li> </ul> <p><b>Advice for watching:</b></p> <ul style="list-style-type: none"> <li>• Use the product in an environment with comfortable light. It is harmful to your eyes to watch in a too bright or too dark environment.</li> <li>• Relax your eyes after a period of time for watching.</li> <li>• When you are watching, the distance which is 3 to 7 times of the screen height should be kept, and it is the best distance to protect eyes and prevent eyestrain.</li> <li>• Adjust the volume to an appropriate level, especially at night.</li> </ul>

## Installation

### Bearing

You can install the product in an unfixd or a wall-mounted way based on your needs. The wall-mounted way can save a large amount of space.

If the product is installed in an unfixd way, use the designated hanger or holder. If you want to use a self-made hanger or holder, ensure that the bearing capacity of it is at least four times of the weight of the product, and the product is installed stably on it.

If the product is installed in a wall-mounted way, the bearing capacity of the surface for installation must be at least four times of the weight of the product. If the surface for installation is the wall or the ceiling of a building, the surface must be made of solid bricks, concrete or other materials with equal intensity. If the product is installed on a surface made of loose material such as an old brick wall, wood plank wall, solid brick wall, or a metal or non-metal structure surface, or a surface with a thick

decoration layer, take necessary consolidating measures to ensure that the product is stably installed.

### Ventilation

Ventilation requirements	Distance to the surface for installation (cm)			
	Left and right sides	Top	Bottom	Back
Nominal power Greater than 100 W	10	20	20	10

 If the product is installed inside a wall or a cabinet, in addition to the preceding requirements, the ventilation area around the bottom, top and two sides must be at least 50% of the sealing surface to ensure proper ventilation.

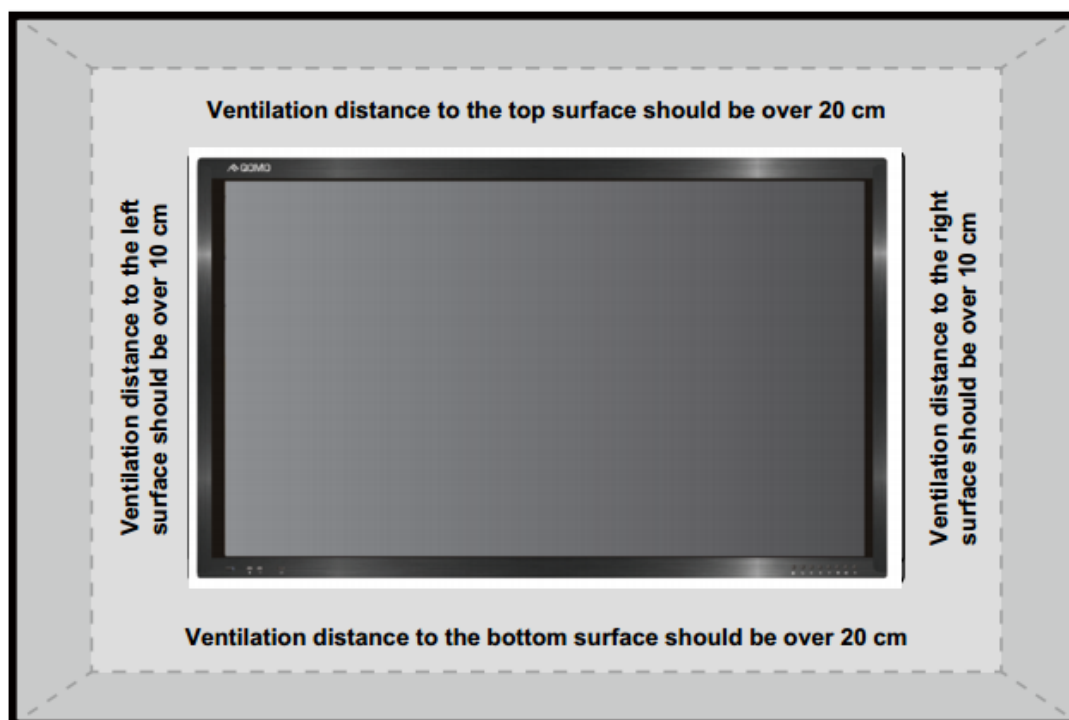

- Note: 1. When the product is installed in a wall-mounted way, the screws need to be installed deeper than 10 mm in the way.
2. Do not block ventilation vents.

## Installation diagram

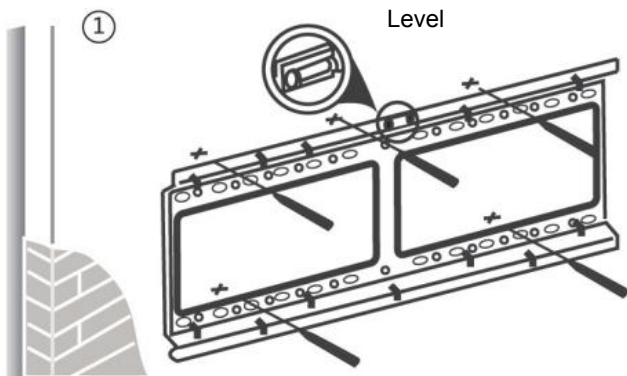

Use a level to locate the holes in horizontal line and mark with pencil where the holes will be located. Then drill holes in the wall.

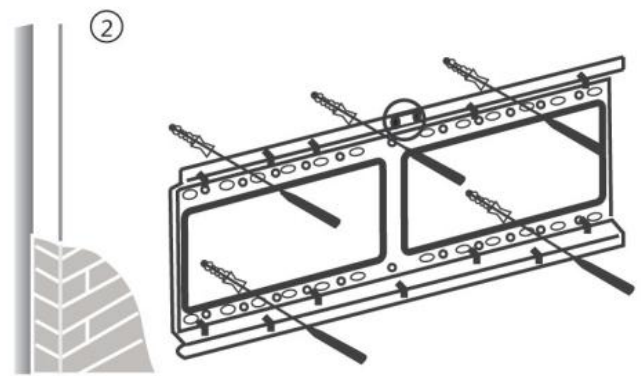

Insert wall plugs into the mounting holes. Push the self-tapping screws through the bracket into the wall plugs and tighten the screws.

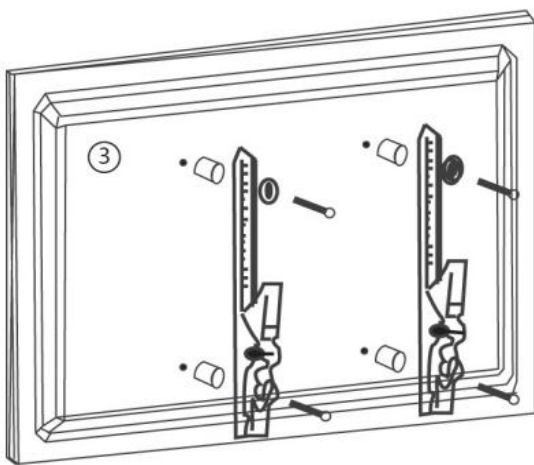

Attach the mounting arms to the back of screen with the screws.

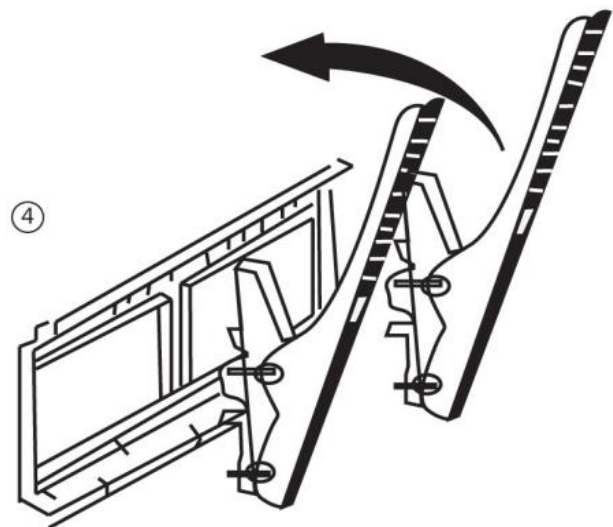

Hang the screen and let it settle into the bracket. Ensure that it is firmly in place.

Note: The horizontal and vertical distance of mounting holes on the back of screen must be within the required distance of bracket.



# Introduction

As our latest independently developed and produced human-machine interactive product, the Journey 13 series interactive touch screen is a multi-functional display for interactive teaching, digital demonstration, multi-media presentation, touch operations and handwriting. They are well designed and produced to meet the needs of education and corporate applications, and provide a user-friendly experience, digital intelligent control as an ideal equipment for schools and companies. You can use your fingers or opaque objects to write, edit and delete any things on the screen.

The product features are as follows:

- Specially designed for teaching and meeting systems.
- With high brightness and high contrast, the display is visible under strong sunlight or in outdoor environments.
- Enter into Eco mode with one-touch button to reduce the power consumption.
- Adopt advanced infrared array scanning and sensing technology, HID driver-free, meaning the product is activated soon after it is powered on.
- Multi-signal sources can be previewed in the window and be switched by touching the screen.
- Vector-based image-editing software with features like high compression and distortion free.
- Multiple pen tools, line styles and colors selections.
- Support real time on-screen editing.
- Shape recognition turns hand-drawn shapes into perfect versions.
- Save files in various formats, including PDF, JPEG, PNG, BMP and etc.
- Multi-touch screen enables several users use the screen together.
- User management enables you to add a new user, delete a user, switch a user and edit user information etc.
- Support handwriting recognition including English, Chinese, numbers and special characters.

# Basic Operation



## ● Power on

- Power the interactive touch screen with the 100V-240V 50Hz/60Hz AC power supply.
- Connect the panel to the power supply. Switch on the rocker switch (on the left bottom of the rear of the panel, next to the power port) to enter standby status. The power indicator turns red.
- Press power button on the control panel or Power on the remote control to turn on the display and built-in PC simultaneously. The power indicator turns green.

## ● Power off

- Press **ECO** on the control panel to temporarily turn off the display.
- Press power button on the control panel or Power on the remote control to enter the standby status. The power indicator turns red.

- In the standby status, switch off the rocker switch to turn off the touch screen.



1. Disconnect the touch screen from power after the touch screen enters standby status.

Otherwise, the screen may be damaged. A sudden power failure may damage the touch screen.

2. Frequent power on and off in a short time may cause faults.

Status of the power indicator is as follows:

Power Indicator	Status
No light	Power off
Red	Standby
Green	Power on

- **OPS Installation**

 **The OPS does not support hot-plugging. Please insert the plug of the OPS after the interactive panel is disconnected from the power.**

Install the OPS by following the following steps:

Step 1: Insert the OPS into the special slot on the rear of the interactive panel.

Step 2: Tighten the screws.

Step 3: Confirm that the OPS is installed correctly.

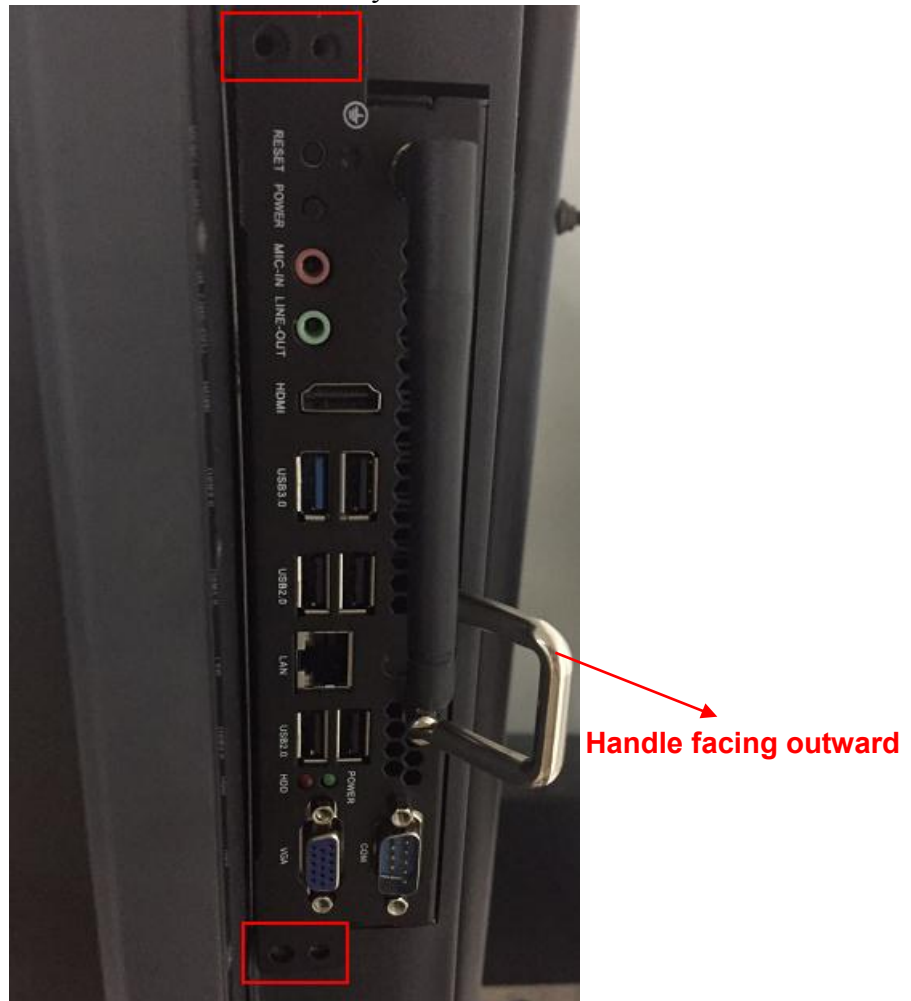

# Remote Control

## Functions of remote control



1. Power on or standby
2. Mute
3. Change channels or enter numbers
4. Return
5. P. MODE: Picture mode  
SMODE: Sound mode
6. Signal source selection
7. Show the current signal source
8. VOL+ / VOL-: Increase/decrease volume
9. CH+ / CH-: Change channel
10. Sleep mode  
NICAM: Select the sound tracks  
ASPECT: Selects picture aspect  
EPG: Electronic program guide
11. ▲ / ▼ / ► / ◀. Up/down/right/left direction buttons  
OK: Confirm
12. Show or hide menu
13. Quit the current interface
14. Play/Pause
15. Rewind or replay certain scenes
16. Buttons for image & text editing
17. Buttons for channel editing

## Instructions of remote control

The usage scope of the remote control includes the vertical distance within five meters in front of the panel, and the area within an angle of 30 degrees from the vertical point to the left and right.

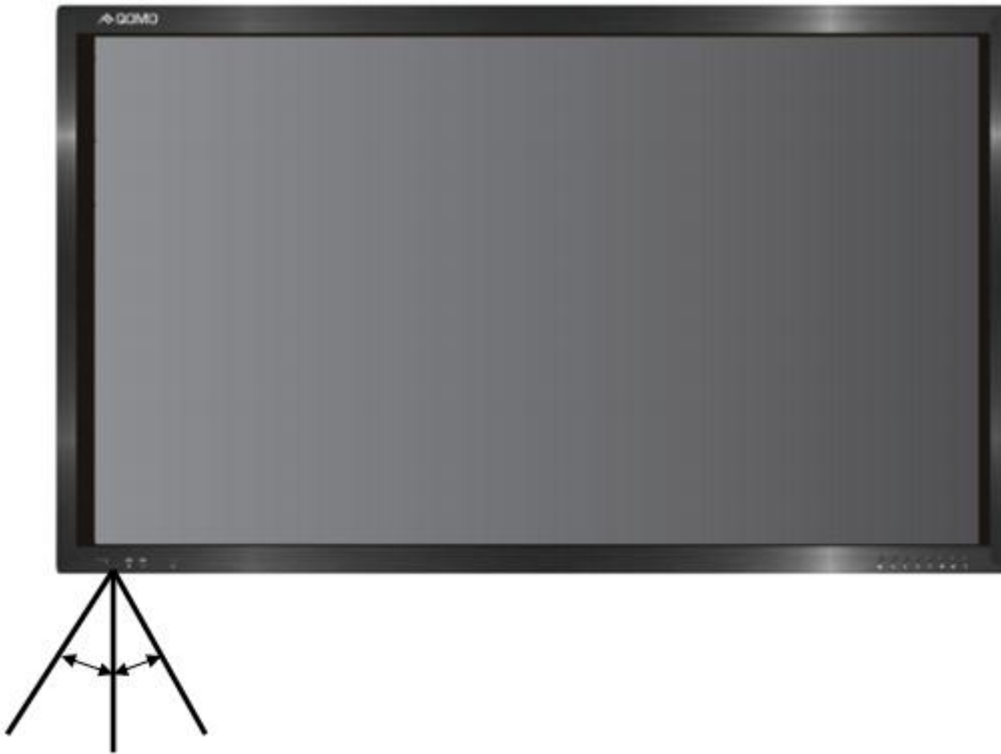

The effective receiving area is about 3 meters with 30° angle from vertical point to the left and right. And the effective receiving area is about 5 meters from the front of device. Note that the remote control signal receiver locates at the position of power indicator.



To avoid probable faults, please read the following instructions and use the remote controller properly.

- Do not drop or beat the remote controller.
- Do not spill water or other liquid on the remote controller.
- Do not put the remote controller on wet items.
- Do not expose the remote controller under sunlight or put it near overheated source.

# Buttons & Ports

## Buttons & ports on the front panel



Power indicator      Front ports



Front control panel buttons



### Power indicator:

- Press power switch on the control panel. The power indicator turns green.
- Press power switch on the control panel to enter the standby status. The power indicator turns red.



### Front ports:



Android USB port











Built-in PC USB port



HDMI port used to connect an external display device



-  Enter/Return to Android home page
-  Return to previous interface
-  Decrease volume    OSD button: ◀
-  Increase volume    OSD button: ▶
-  Enter ECO mode to turn off the display
-  Enter/Exit the OSD menu
-  Enter/Exit signal source menu
-  Power switch: on or standby

## Ports on the rear panel for 65" & 75"

- Ports on bottom of mainboard

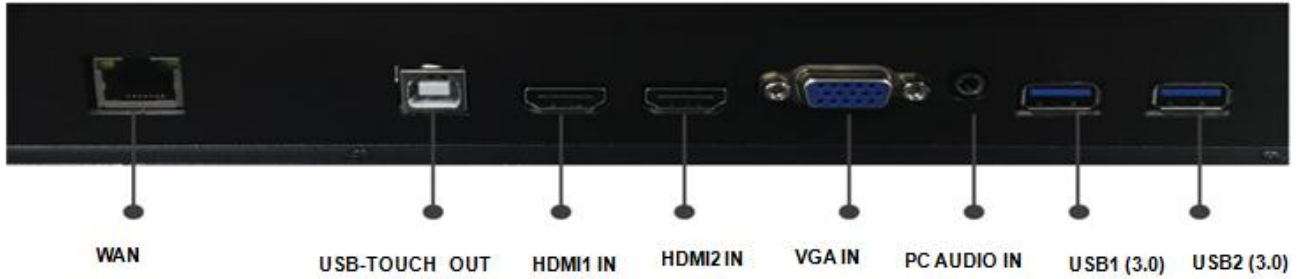

- Ports on side of mainboard

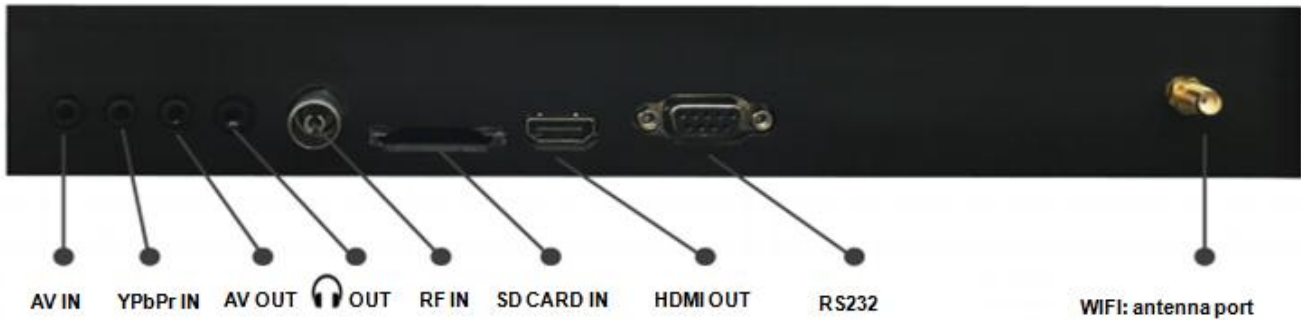

## Ports on the rear panel for 86"

- Ports on side of mainboard

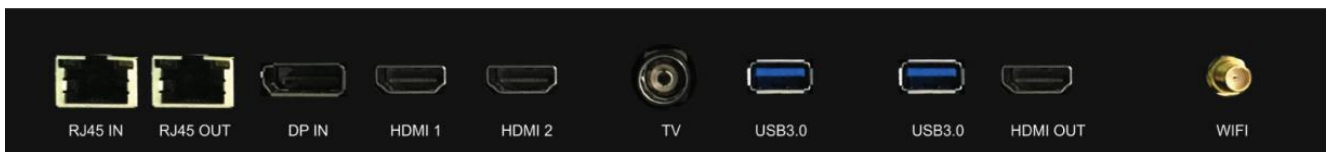

- Ports on bottom of mainboard

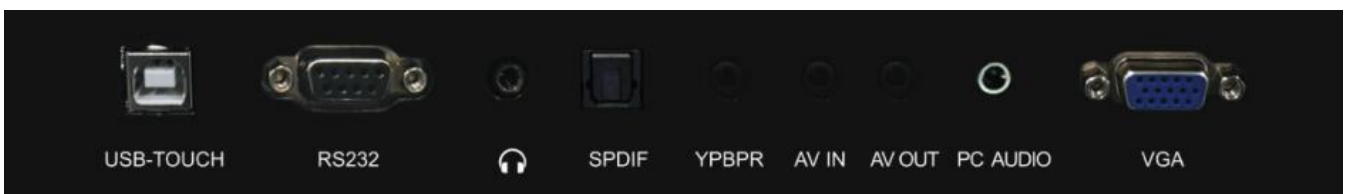

## RS232 code list

There are two RS232 code lists. Please refer to corresponding list according to your panel model.

RS232 Code List for 65" & 75"	
<b>6 bytes command</b>	<b>Baud rate: 115200      Data bits: 8      Check bit: none</b>
Start code 99, <b>Customer code</b> (Public Version: XX = 23), <b>Function ID code</b> , Device ID code (It is generally 01, unless otherwise noted) , <b>Check code</b> + <b>Function ID code</b> = FF, End code AA.	
HOME	99 XX 00 01 FF AA
Power Off	99 XX 01 01 FE AA
Power On	99 XX 80 01 7F AA
Mute	99 XX 02 01 FD AA
Sound Mode	99 XX 03 01 FC AA
Image Mode	99 XX 04 01 FB AA
ATV	99 XX 07 01 F8 AA
DTV	99 XX 05 01 FA AA
Video	99 XX 08 01 F7 AA
Component	99 XX 0A 01 F5 AA
Computer 1	99 XX 0B 01 F4 AA
Computer 2	99 XX 0C 01 F3 AA
Computer 3	99 XX 0D 01 F2 AA
Computer 4	99 XX 06 01 F9 AA
HDMI1	99 XX 0E 01 F1 AA
HDMI2	99 XX 0F 01 F0 AA
Front Computer	99 XX 10 01 EF AA
Built-in Computer	99 XX 11 01 EE AA
DP	99 XX 09 01 F6 AA



Menu	99 XX 12 01 ED AA
Signal Source	99 XX 13 01 EC AA
Exit	99 XX 14 01 EB AA
Listen only audio	99 XX 15 01 EA AA
Volume +	99 XX 17 01 E8 AA
Volume -	99 XX 18 01 E7 AA
Channel +	99 XX 19 01 E6 AA
Channel -	99 XX 1A 01 E5 AA
Screenshot	99 XX 1B 01 E4 AA
Screen Display	99 XX 1C 01 E3 AA
Display ratio	99 XX 1E 01 E1 AA
Sleep Mode	99 XX 1D 01 E2 AA
Auto Adjustment	99 XX 1F 01 E0 AA
Up	99 XX 22 01 DD AA
Down	99 XX 23 01 DC AA
Left	99 XX 24 01 DB AA
Right	99 XX 25 01 DA AA
Confirm	99 XX 26 01 D9 AA
Multi-media	99 XX 27 01 D8 AA
Device Status Query	99 XX 28 01 D7 AA

### 1. Status Query Feedback 8 byte data

Start code 99, Board card model, Power On, Current channel, Volume, Sound mode, Check code (Current channel + Volume + Sound mode), End code AA

1. **Boar card model**      **01**
2. **Power on:**            **01**
3. **Current channel:**

Computer 1 = 0B, Computer 2 = 0C, Computer 3 = 0D, Computer 4 = 06, ATV = 07, DTV = 05, Video = 08, Aberration = 0A, HDMI1 = 0E, HDMI2 = 0F, DP= 09, Front computer = 10, Built-in computer = 11, Multi-media or Application state of third party = 0E

4. **Volume: 0~100 (decimal) = 0~64 (hexadecimal), mute state = 65**
5. **Sound mode : Standard = 01, Music = 02, Movie = 03, Sports = 04, User = 05, Immersive 1 = 06, Immersive 2 = 07**

E.g.: 99 01 01 0C 32 03 41 AA

Note: Power off state without any feedback.

### RS232 Code List for 86”

**RS232 Setting: Baudrate: 115200 bps; Parity check: no parity; Stop bit: one; Data bit: 8 bits;**

RS232 Packet1 (Packet size : 8 bytes)	0	1	2	3	4	5	6	7
	HEADER1	HEADER2	HEADER3	CMD1	CMD2	DATA1	DATA2	DATA3
	0x55	0x54	0x53	0xXX	0xXX	0xXX	0xXX	0xXX
<b>Command List</b>								
FUNCTION	HEADER1	HEADER2	HEADER3	CMD1	CMD2	DATA1	DATA2	DATA3
Start Panel remotely	0x55	0x54	0x53	0x50	0x4E	0x21	0x21	0x21
Shutdown panel remotely	0x55	0x54	0x53	0x50	0x46	0x21	0x21	0x21
Get Signal Source (bidirectional)	0x55	0x54	0x53	0x50	0x53	0x21	0x21	0x21
Set Signal Source (DTV)	0x55	0x54	0x53	0x50	0x73	0x21	0x21	0x21
Set Signal Source (ATV)	0x55	0x54	0x53	0x50	0x73	0x21	0x21	0x21
Set Signal Source (Video 1)	0x55	0x54	0x53	0x50	0x73	0x30	0x30	0x21
Set Signal Source (Video 2)	0x55	0x54	0x53	0x50	0x73	0x30	0x31	0x21
Set Signal Source (Component)	0x55	0x54	0x53	0x50	0x73	0x30	0x32	0x21
Set Signal Source (HDMI 1)	0x55	0x54	0x53	0x50	0x73	0x30	0x33	0x21
Set Signal Source (HDMI 2)	0x55	0x54	0x53	0x50	0x73	0x30	0x34	0x21
Set Signal Source (PC1)	0x55	0x54	0x53	0x50	0x73	0x30	0x35	0x21
Set Signal Source (PC2)	0x55	0x54	0x53	0x50	0x73	0x30	0x36	0x21
Set Signal Source (S terminal)	0x55	0x54	0x53	0x50	0x73	0x30	0x37	0x21
Set Signal Source (Built-in HDMI)	0x55	0x54	0x53	0x50	0x73	0x30	0x38	0x21
Set Signal Source (External HDMI)	0x55	0x54	0x53	0x50	0x73	0x30	0x39	0x21
Get Display Mode (Bidirectional)	0x55	0x54	0x53	0x50	0x44	0x31	0x30	0x21
Set Display Mode (16:9)	0x55	0x54	0x53	0x50	0x64	0x31	0x31	0x21
Set Display Mode (4:3)	0x55	0x54	0x53	0x50	0x64	0x21	0x21	0x21
Set Display Mode (Figure Mode)	0x55	0x54	0x53	0x50	0x64	0x30	0x21	0x21

<b>Set Display Mode (Full View Mode)</b>	0x55	0x54	0x53	0x50	0x64	0x31	0x21	0x21
<b>Set Display Mode(Subtitle Mode)</b>	0x55	0x54	0x53	0x50	0x64	0x32	0x21	0x21
<b>Set Display Mode(Movie Mode)</b>	0x55	0x54	0x53	0x50	0x64	0x33	0x21	0x21
<b>Get Display Mode (bidirectional)</b>	0x55	0x54	0x53	0x50	0x50	0x34	0x21	0x21
<b>Set Image Mode(Standard)</b>	0x55	0x54	0x53	0x50	0x70	0x35	0x21	0x21
<b>Set Image Mode(Bright)</b>	0x55	0x54	0x53	0x50	0x70	0x21	0x21	0x21
<b>Set Image Mode(Soft)</b>	0x55	0x54	0x53	0x50	0x70	0x30	0x21	0x21
<b>Set Image Mode(Customized)</b>	0x55	0x54	0x53	0x50	0x70	0x31	0x21	0x21
<b>Get Sound Mode (bidirectional)</b>	0x55	0x54	0x53	0x50	0x41	0x32	0x21	0x21
<b>Set Sound Mode (Standard)</b>	0x55	0x54	0x53	0x50	0x61	0x33	0x21	0x21
<b>Set Sound Mode (Music)</b>	0x55	0x54	0x53	0x50	0x61	0x21	0x21	0x21
<b>Set Sound Mode (News)</b>	0x55	0x54	0x53	0x50	0x61	0x30	0x21	0x21
<b>Set Sound Mode (Movie)</b>	0x55	0x54	0x53	0x50	0x61	0x31	0x21	0x21
<b>Set Sound Mode (Customized)</b>	0x55	0x54	0x53	0x50	0x61	0x32	0x21	0x21
<b>Get Volume (bidirectional)</b>	0x55	0x54	0x53	0x50	0x56	0x33	0x21	0x21
<b>Set Volume(000-100)</b>	0x55	0x54	0x53	0x50	0x76	0x34	0x21	0x30~0x39
<b>Get Channel (bidirectional)</b>	0x55	0x54	0x53	0x50	0x43	0x21	0x21	0x21
<b>Set Channel(000-999)</b>	0x55	0x54	0x53	0x50	0x63	0x30~0x31	0x30~0x39	0x30~0x39
<b>Screen brighten</b>	0x55	0x54	0x53	0x50	0x42	0x21	0x21	0x21
<b>Screen darken</b>	0x55	0x54	0x53	0x50	0x62	0x30~0x39	0x30~0x39	0x21
<b>Mute</b>	0x55	0x54	0x53	0x50	0x4D	0x21	0x21	0x21
<b>Channel+</b>	0x55	0x54	0x53	0x50	0x3E	0x21	0x21	0x21
<b>Channel-</b>	0x55	0x54	0x53	0x50	0x3C	0x21	0x21	0x21
<b>Volume+</b>	0x55	0x54	0x53	0x50	0x2B	0x21	0x21	0x21
<b>Volume-</b>	0x55	0x54	0x53	0x50	0x2D	0x21	0x21	0x21
<b>Menu</b>	0x55	0x54	0x53	0x50	0x6D	0x21	0x21	0x21
<b>Signal Source</b>	0x55	0x54	0x53	0x50	0x58	0x21	0x21	0x21
<b>Up(keyboard)</b>	0x55	0x54	0x53	0x50	0x55	0x21	0x21	0x21
<b>Down(keyboard)</b>	0x55	0x54	0x53	0x50	0x44	0x21	0x21	0x21
<b>Left (keyboard)</b>	0x55	0x54	0x53	0x50	0x4C	0x21	0x21	0x21
<b>Right(keyboard)</b>	0x55	0x54	0x53	0x50	0x52	0x21	0x21	0x21
<b>Ok(Keyboard)</b>	0x55	0x54	0x53	0x50	0x4F	0x21	0x21	0x21
<b>Back Button</b>	0x55	0x54	0x53	0x50	0x45	0x21	0x21	0x21
<b>Home button</b>	0x55	0x54	0x53	0x50	0x48	0x21	0x21	0x21

# Operation Interface

## ■ Android Home Page



Android home page provides preview function that displays three parts. Click  on the toolbar or Press HOME button to enter the home page.

1. Click the signal source in part ① and its thumbnail will be shown in part ②. Then click part ② to enter its corresponding signal source.
2. Part ③ includes four icons **Settings**, **Chrome Browser**, **Applications** and **Explorer**. Click the icon to enter its corresponding interface.

 **Settings:** Click the icon to enter the Android setting interface.

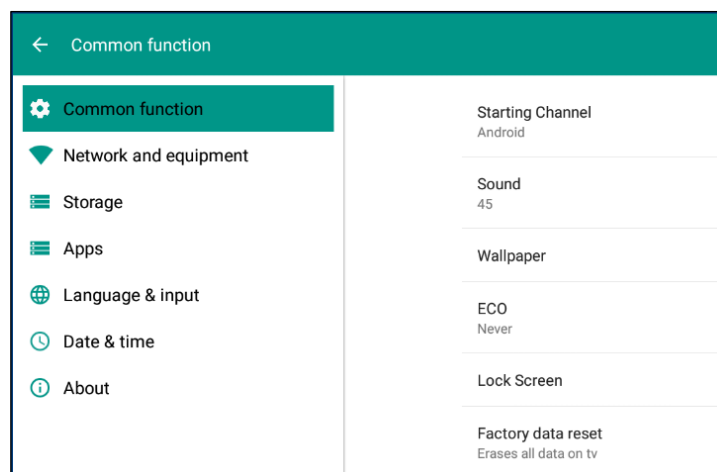



**Browser:** Built-in browser.

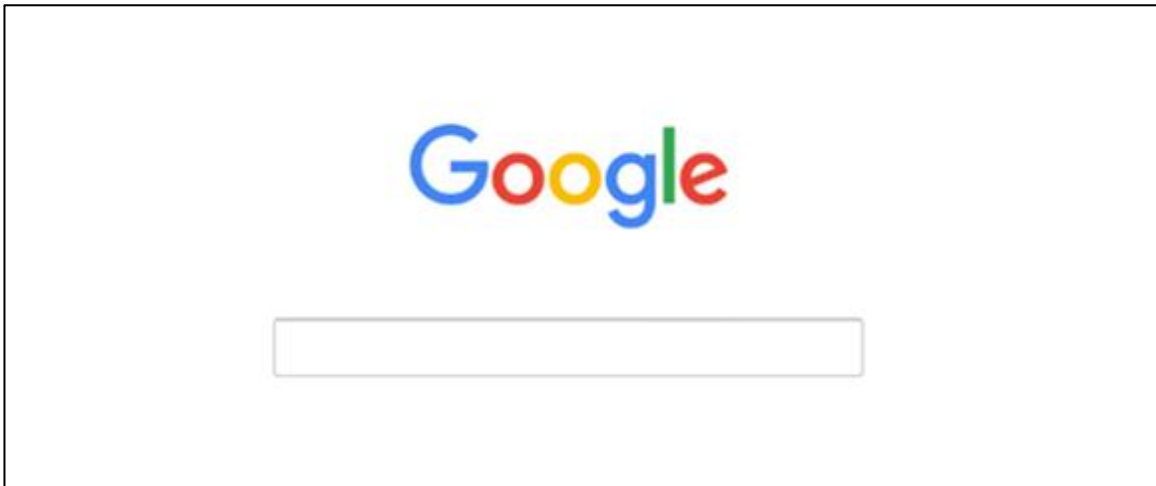

**Applications:** Click the icon to access more applications interface.

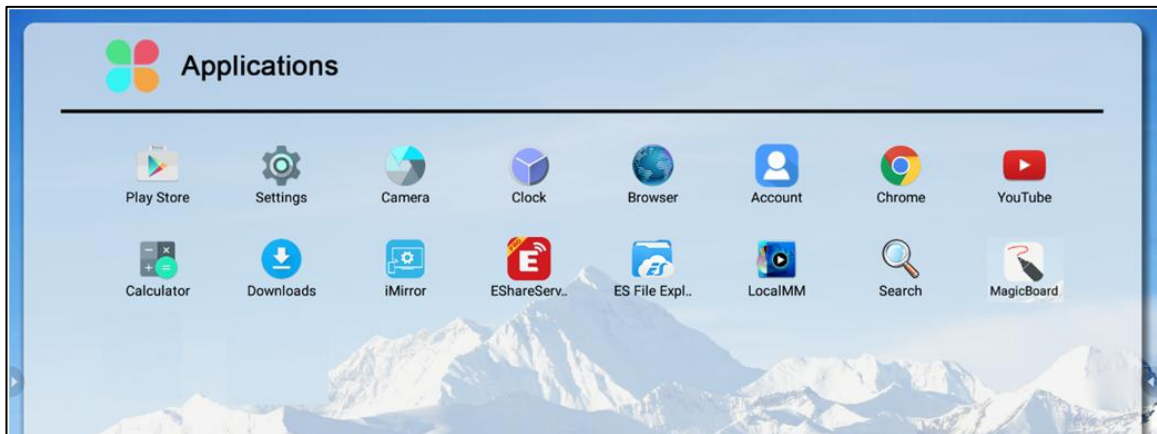

**Explorer:** Click the icon to manage the file.

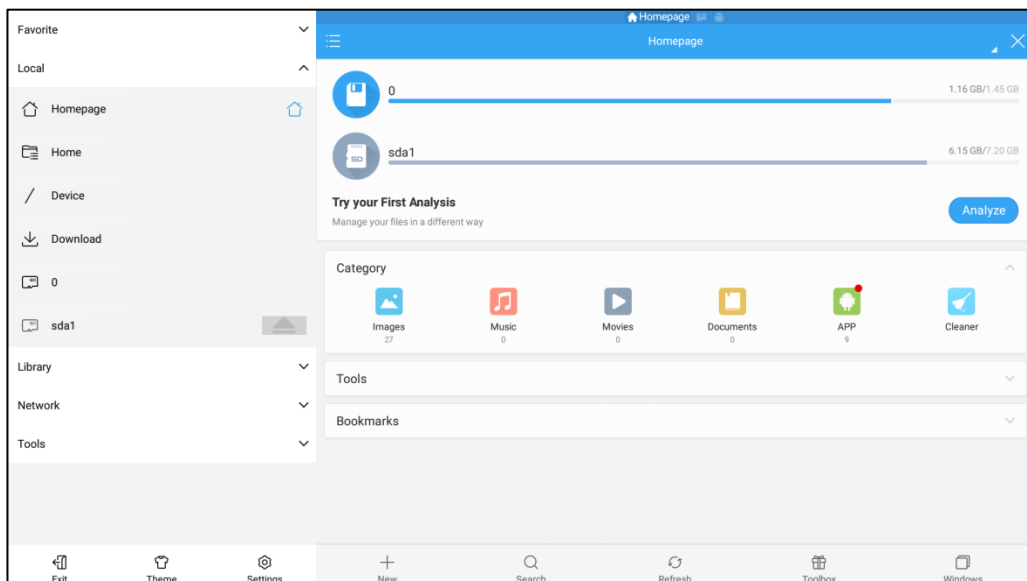

## ■ Android Settings

Click  icon on home page or on bottom-up toolbar or press **Setting** button on the front panel to enter Android setting interface. **Common function, Network and equipment, Storage, Language & input, Date & time** and **About** are displayed on the interface. Press **▲▼◀▶** on the remote control or click the item directly to select the one you want to change its setting.

### 1. Common function

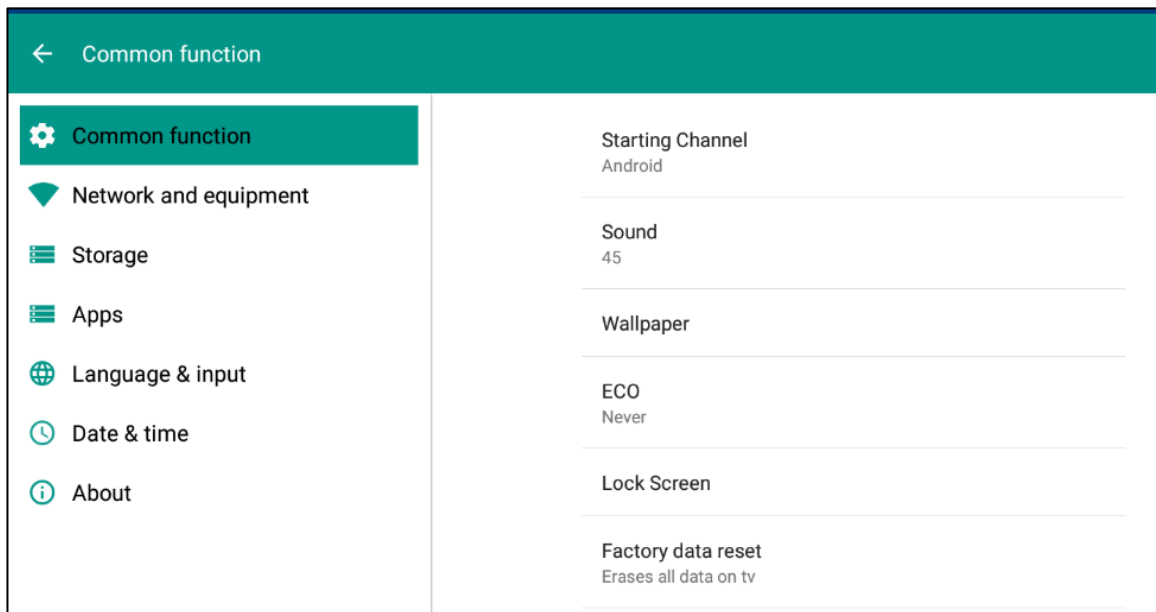

Click **Common function** to set Starting Channel, Sound, Wallper, ECO, Lock Screen and Factory Data Reset.

#### 1) Starting Channel

Start the Panel and enter the channel you set directly.

#### 2) Sound

Click Sound and the icon  pops up. Slide right or left to increase or decrease the volume.

#### 3) Wallpaper

Set dynamic or static wallpaper.

#### 4) ECO

Set the time to enter ECO mode automatically.

#### 5) Lock Screen

Set the time to lock screen automatically and password to unlock the screen.

## 6) Factory data reset

Click Factory data reset and then click Reset TV to erase all the data on TV.

## 2. Network and equipment

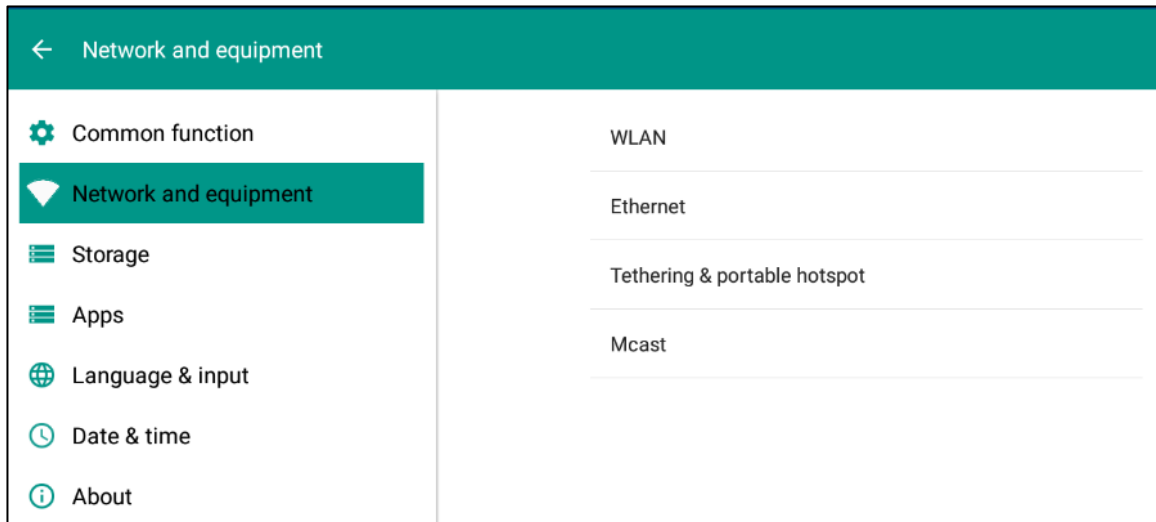

Click **Network and equipment** to set **WLAN**, **Ethernet**, **Tethering& portable hotspot** and **Mcast**.

### 1) WLAN

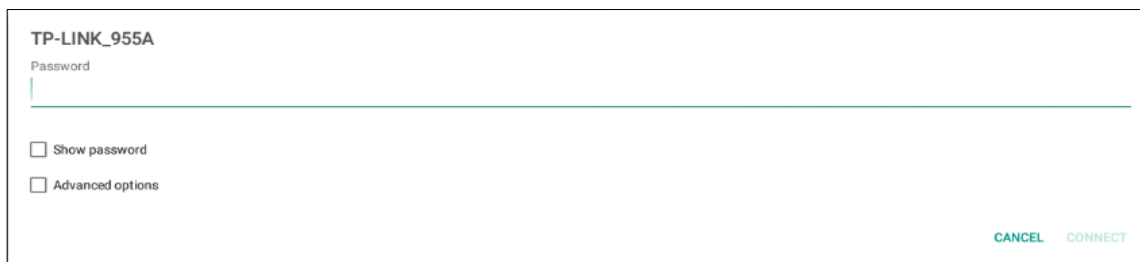
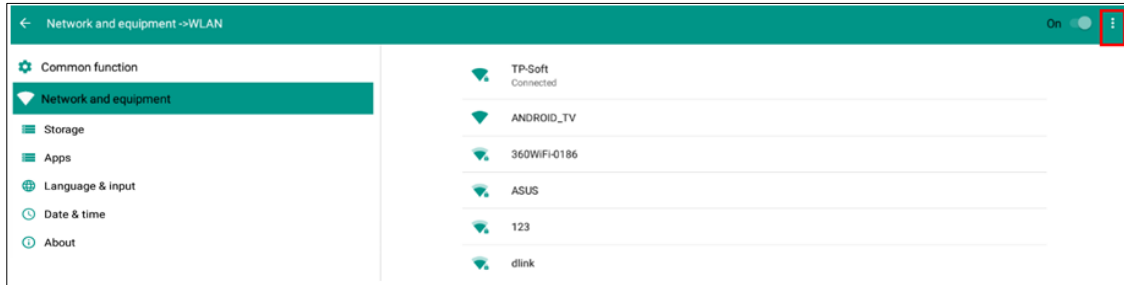

Select an available wireless network AP and enter the password to be connected. Click  and a

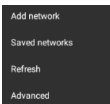
menu  pops up. Select “Advanced” for further setting.

### 2) Ethernet

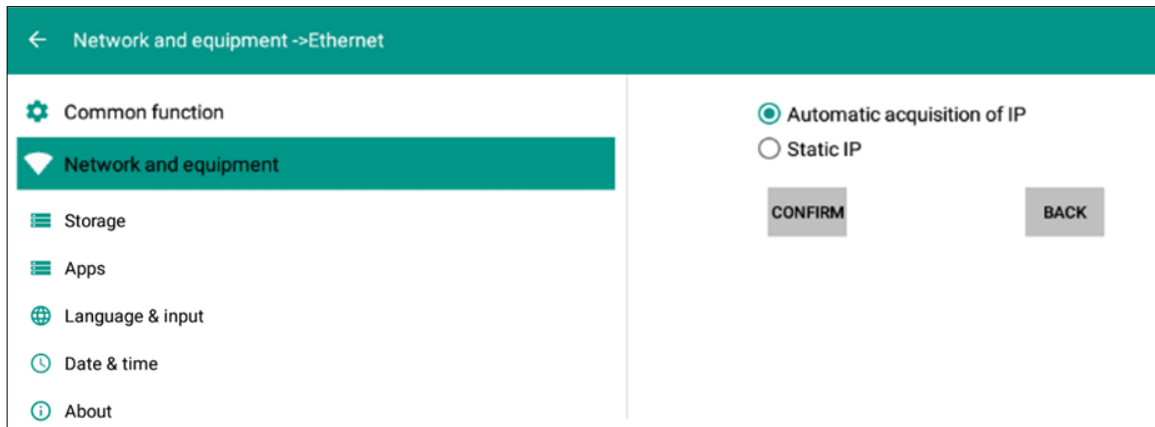

If the panel is connected with LAN cable and supports Dynamic Host Configuration Protocol (DHCP), the system will automatically configure the internet protocol (IP) value.

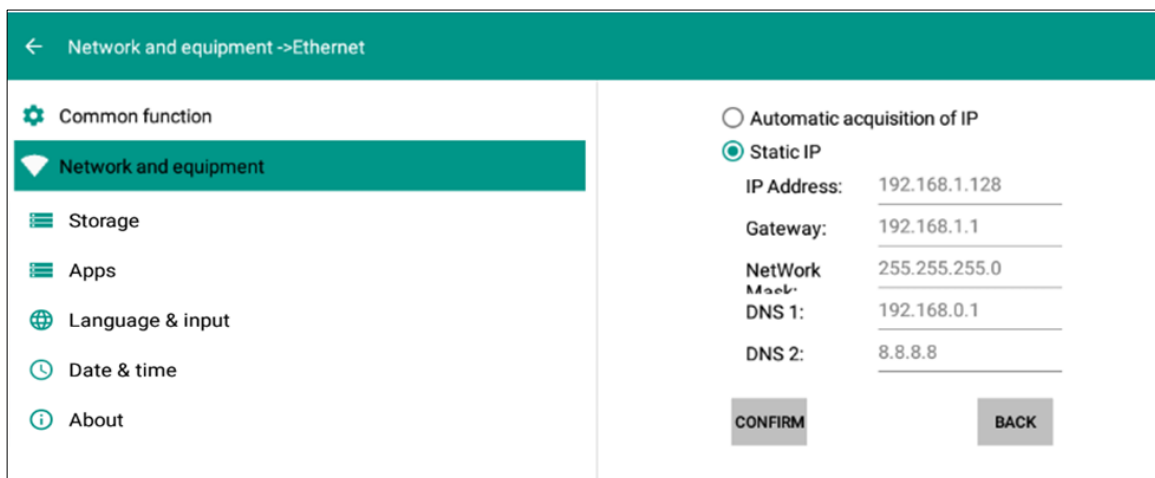

If the network protocol needs to be set manually, enter the IP address, Gateway and DNS server parameters by using the on-screen keyboard or remote control.

### 3) Tethering & portable hotspot

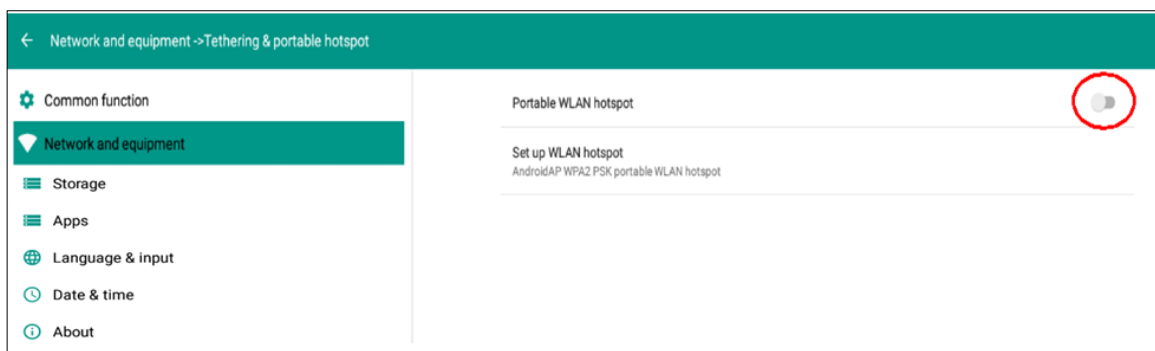



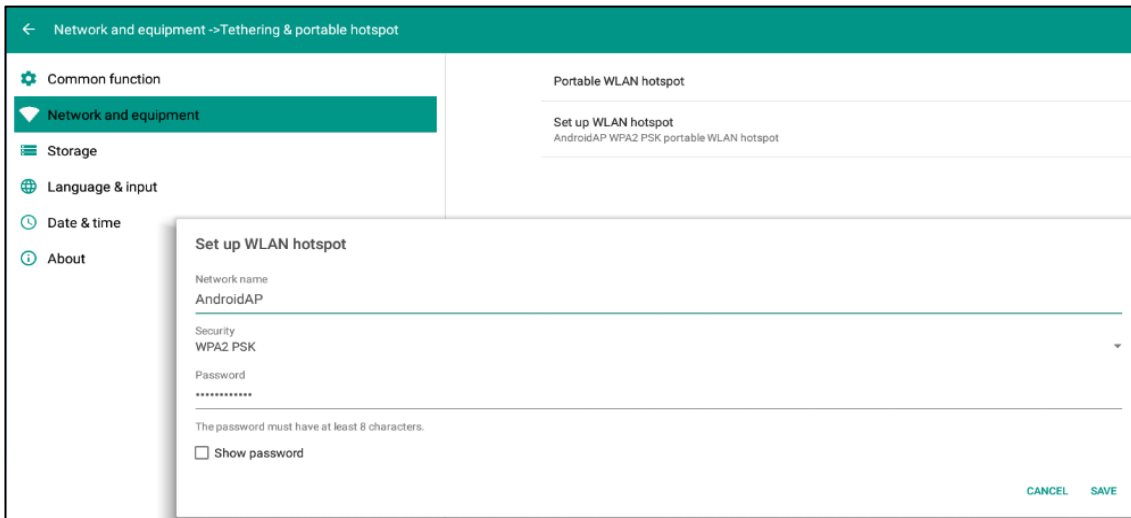

Click Portable WLAN hotspot to set the panel as a wifi hotspot or click Set WLAN hotspot to set related WIFI hotspot attributes in the displayed window.

### 3. Storage

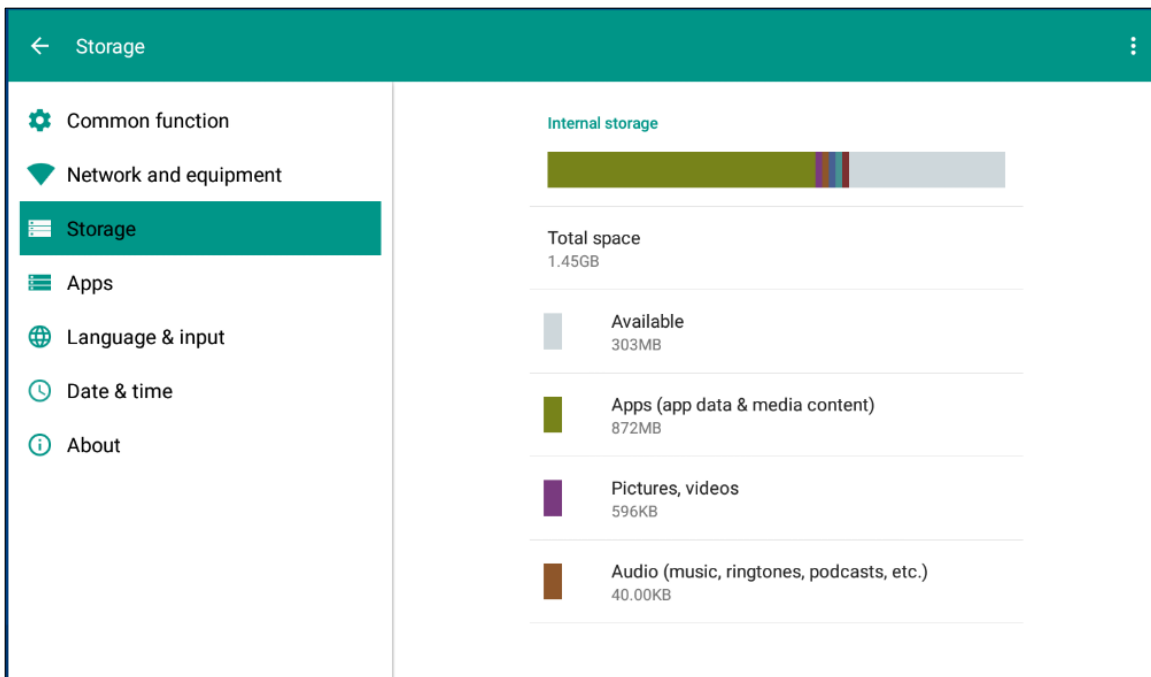

Click **Storage** to check internal storage and USB storage. Click **Storage>Apps** to check and manage the applications installed in Android system. You can force to stop the programme or uninstall it.

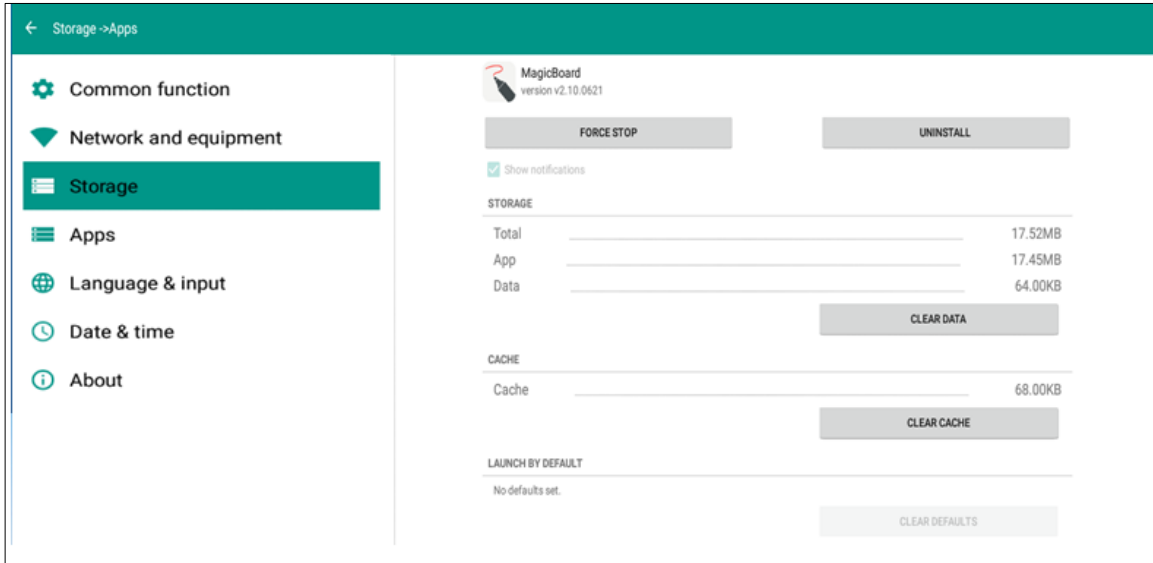

#### 4. Apps

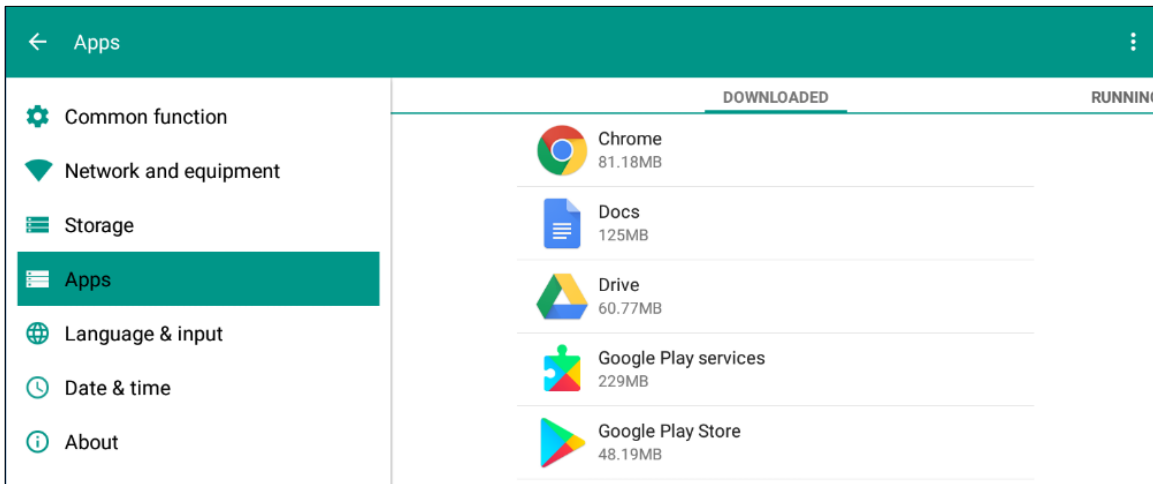

Check all Apps installed and running in Android system. Click corresponding app to uninstall or stop it.

Note: You can't uninstall app pre-installed in the firmware.

#### 5. Language & input

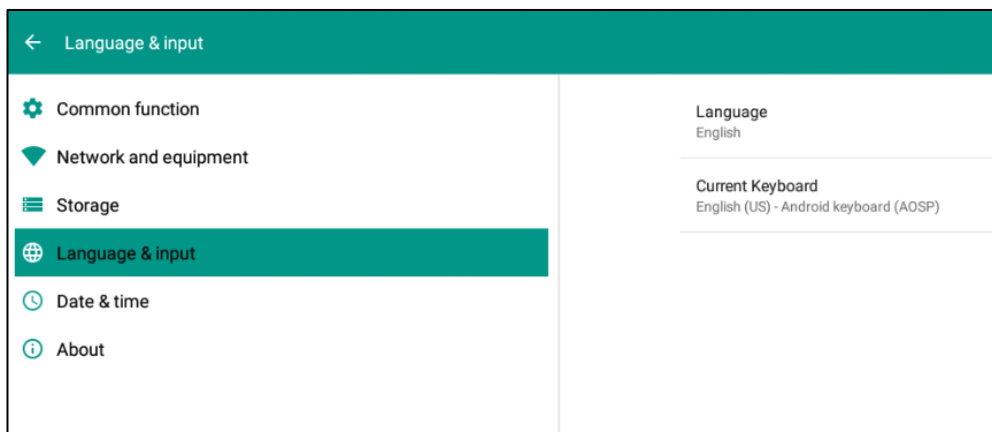

## 6. Date & time

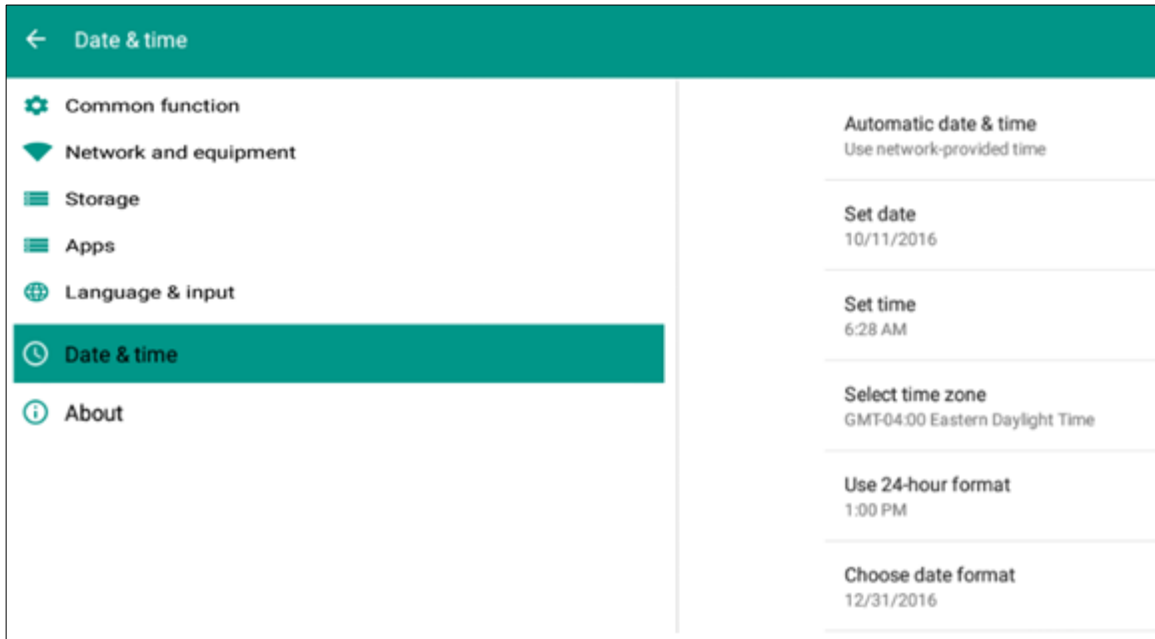

Click Date & Time to change time format, time zone and etc.

## 7. About

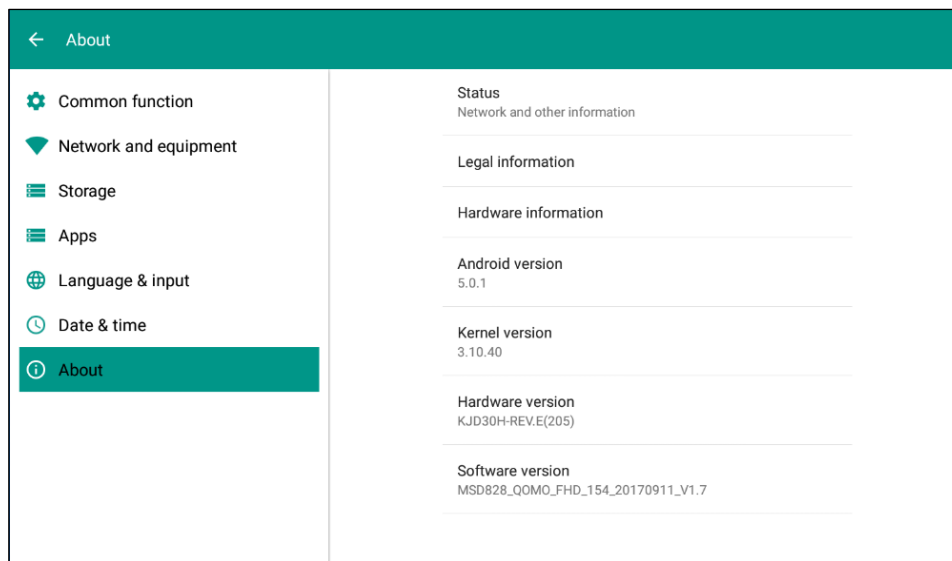

Click **About** to check network status, model, Android version, Kernel version and etc. Click **Status** and enter its page to get the Mac address.

## ■ Built-in PC Interface



1. Select PC signal source to enter PC interface. The following are three ways to select a signal source channel.

- Swipe your finger up from the bottom edge to bring up a toolbar then click **input**.
- Press **SOURCE** button on the remote control.
- Press  button on the front control panel.

In the signal source page, select a channel and press OK or click the channel icon directly to enter it.

2. Operate the built-in PC just like operating an ordinary computer.

3. Shut down PC before you press the button  on the front control panel to turn off the panel. Do not power off a running PC suddenly to avoid data lose. Or you can press Power button to turn off PC and panel at the same time.

## ■ Other Source Settings

When you switch to other signal sources like PC (OPS), HDMI, VGA and etc, settings interface will be displayed as follows: **Picture**, **Sound** and **Setting**. Note that  TV setting is disabled.

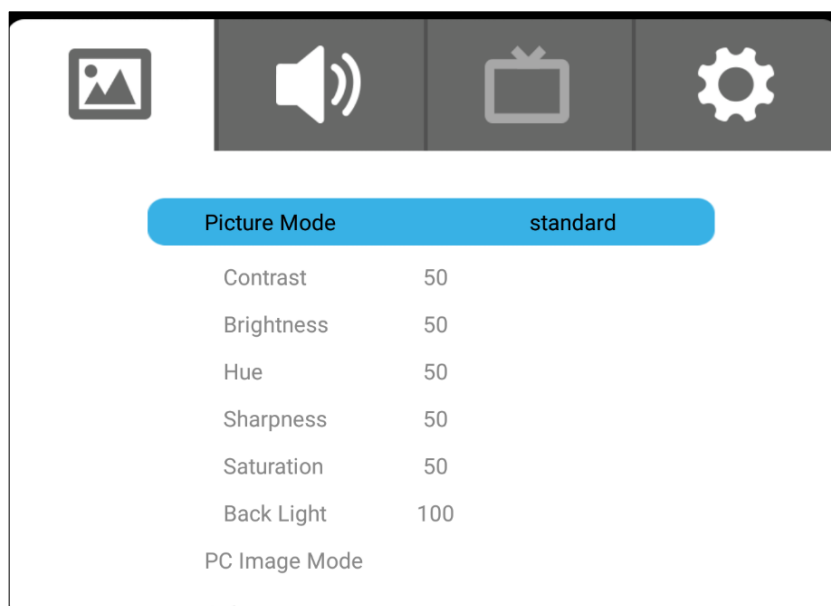

Click an icon to set the option or press ▲▼◀▶ button on remote control to switch the options.

- Press ▲/▼ button to select.
- Press OK button to confirm the selection.
- Press menu button to return to the parent menu.
- Press EXIT button to quit.

## ■ Bottom-up Toolbar



The toolbar can be invoked in any signal source interface. Swipe up from the bottom of screen and it will appear.



Buttons	Functions
Back	Return to previous interface
Home	Return to Android home page
Task	Switch or end the running programs
Input	Change signal source channel
Setting	Click to enter setting interface
Volume	Slide to increase or decrease the volume
Mute	Click to mute
Light	Slide to increase or decrease the brightness
Capture	Take a screenshot and automatically save it
Lock	Click to lock the screen
Note	Quick to annotate







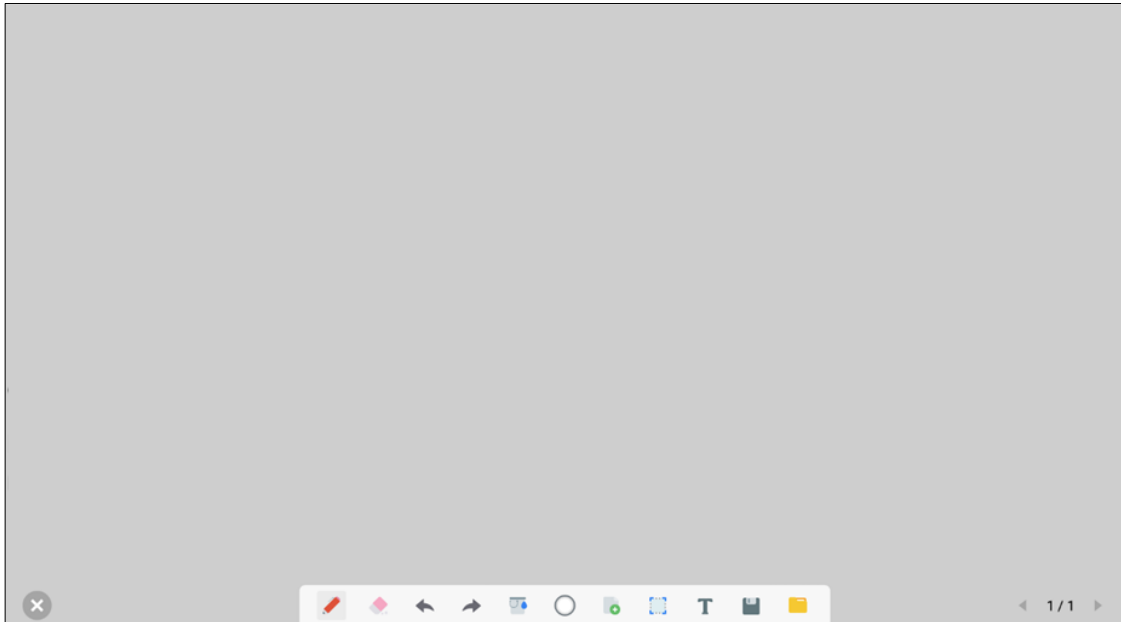



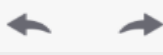

## ■ Annotation software - MagicBoard

MagicBoard provides various functions like annotation, capture, quick-access Apps & Docs and etc.

Click  icon to enter whiteboard interface. And click  icon to fold/unfold the toolbar.





**MagicBoard Interface**

Icons	Functions
	Click to exit the program or Select to keep it running in the background
	Click “<” or “>” to switch current slide and click page number to skim through all slides or quickly switch to a certain slide.
	Pen
	Erase the annotations
	Undo/Redo
	Background color
	Fold/unfold the toolbar
	Add a new slide
	Rectangular selection
	Add a text (Check “Marquee” box to create a scrolling text.)
	Save file
	Quick access files

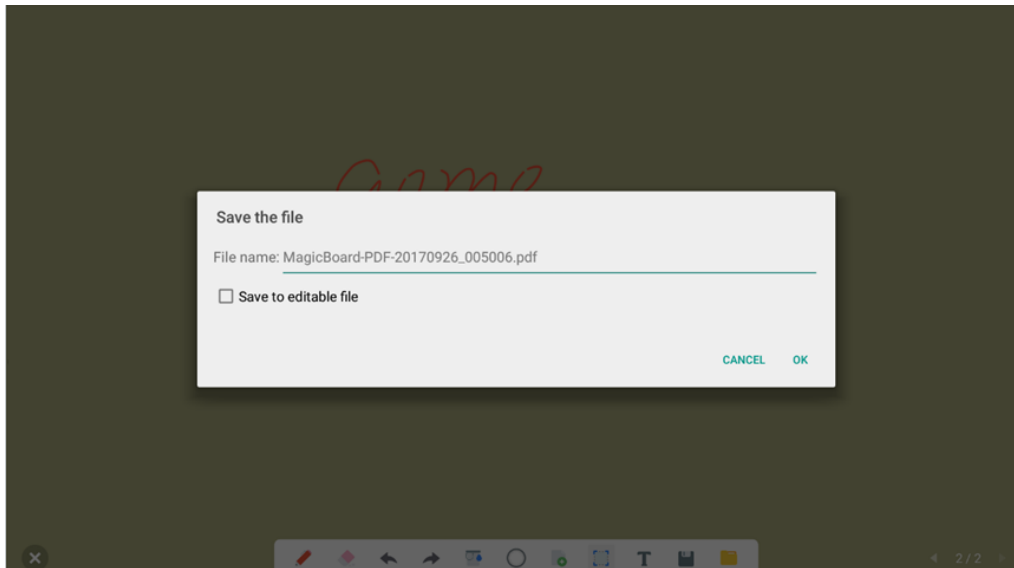
## 1. Save file



Click  icon to save the file. Check “Save to editable file” box so that you can reedit this file next time. You can open this editable file through DOC of File Management . Or you can save the file in PDF format and scan QR code to share the file. Note that you mobile device should be in the same network with Magicboard.

## 2. File management

Skim through files in sdcard or USB flash drive. View image, video, music, documents and all the Apps installed. Click corresponding App icon to open the App.

Click “Doc”, long press the file and you can rename or delete the file.

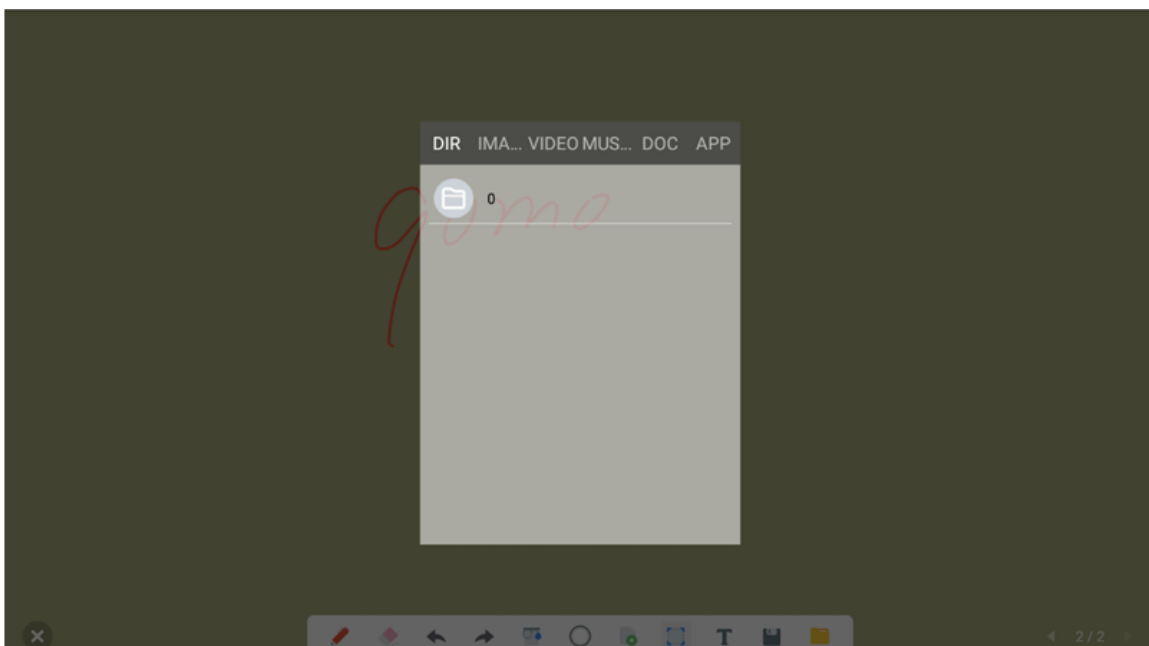

### 3. Whiteboard running in the background

Click  icon then click “Background” and the whiteboard will run in the background.

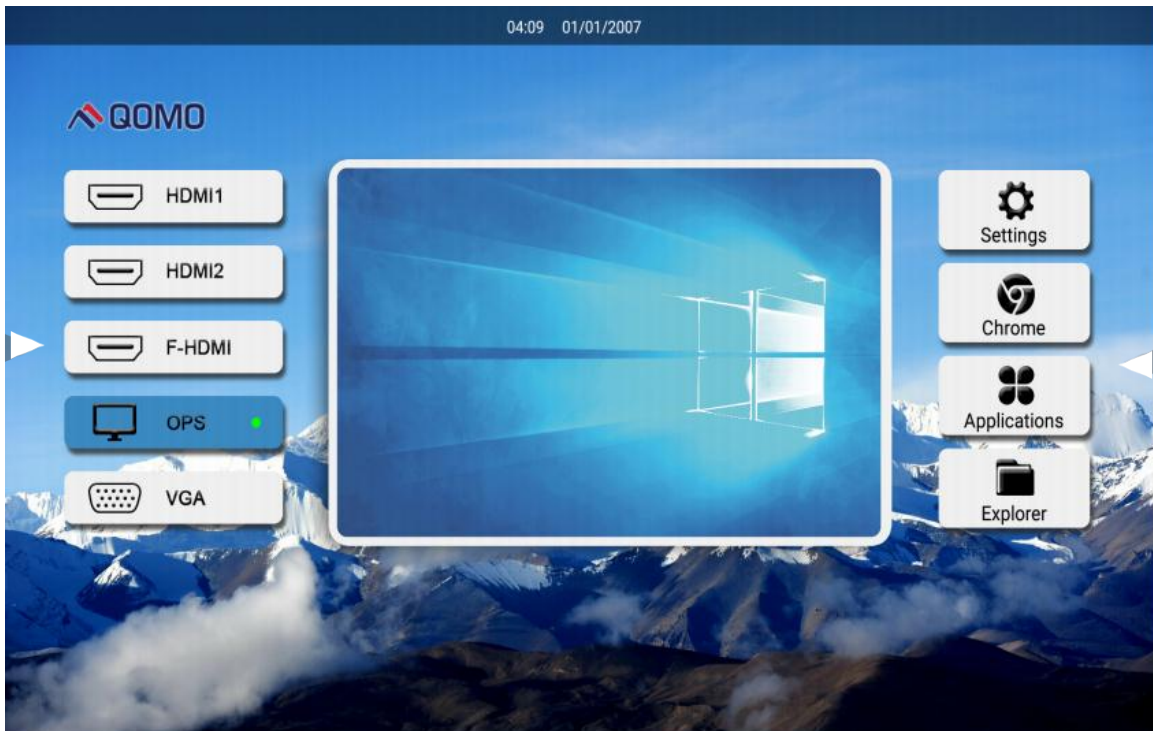









Icon  will appear on both sides. Click either of them to unfold the tools. Note that floating icons will float in every single source for annotation.













Floating Tool Bar	
Buttons	Functions
	Return to previous interface



	Return to the Android Home Page
	Quick access files
	Annotation mode
	Save annotation as an image or scan QR code to share the annotation
	Enter the whiteboard
	Rectangular screenshot
	Window Shade
	Adjust volume

## Included Accessories

Picture	Name	Quantity
	Remote control	*1
	Battery (AAA)	*2
	Pen	*2
	Pointer	*1
	1.8m power cable	*1
	3m HDMI cable	*1
	3m USB cable (A-B)	*1
	Bracket	*1
	Antenna sticks for PC and Android	*2
	Warranty card	*1
	CD	*1

# Troubleshooting

Problem	Cause	Solution
The service program fails to be connected.	The driver program isn't properly installed.	Install the driver program properly.
	The USB port (lead) is not connected or is faulty.	Change the USB lead or check if the USB port is faulty.
	Infrared tube is obscured.	Make sure infrared tubes have not been obscured.
Repositioning is required every time the panel is switched on.	The computer is equipped with a recovery card.	Disable computer protection and perform the positioning again.
The cursor of the pen is unstable when the pen is used.	The writing method is incorrect.	You are advised to use the pen rather than a finger to write. Hold the pen as far to the nib as possible. The angle between the pen and display needs to be greater than 60 degrees. Do not touch the display with your sleeve or wrist.
	Strong light or infrared interference exists.	Remove the interference source or change the using environment.
The handwriting is discontinuous. (Part of the handwriting cannot be displayed.)	The writing method is incorrect.	You are advised to use the pen rather than a finger to write. Hold the pen as far to the nib as possible. The angle between the pen and display needs to be greater than 60 degrees. Do not touch the display with your sleeve or wrist.
	The covering area of the nib does not meet the requirement or the nib is too small.	Change the nib or use a pen with larger covering area.
	Infrared tube is obscured.	Check if infrared tubes are

		obscured.
	Strong light or infrared interference exists.	Remove the interference source or change the using environment.
The handwriting can't be displayed.	The color of the pen is the same as or similar to the background color.	Change the color of the pen.
	Your hand or other objects are on the display when you are writing.	You are advised to use the pen rather than a finger to write. Hold the pen as far to the nib as possible. The angle between the pen and display needs to be greater than 60 degrees. Do not touch the display with your sleeve or wrist.
	Strong light or infrared interference	Remove the interference source or change the using environment.
	The writing method is incorrect.	You are advised to use the pen rather than a finger to write. Hold the pen as far to the nib as possible. The angle between the pen and display needs to be greater than 60 degrees. Do not touch the display with your sleeve or wrist.
No sound is played and no image is displayed.	<ul style="list-style-type: none"> <li>● Check whether the power plug is inserted into the power socket and whether the panel is powered on.</li> <li>● Check whether the rocker switch on the interactive panel is switched on.</li> <li>● Check whether the Standby button on the panel is pressed.</li> <li>● Check whether the video and audio input cables are connected correctly.</li> <li>● Check whether the panel is switched to the right signal source.</li> <li>● Check the settings on image brightness and contrast.</li> <li>● Check the volume.</li> </ul>	

Image is displayed properly, but no sound is played.	<ul style="list-style-type: none"> <li>● Check the volume.</li> <li>● Check whether the Mute button on the remote control is pressed.</li> <li>● Check whether the audio cable between the PC and interactive panel is connected correctly.</li> </ul>
No image is displayed or the image is black and white.	<ul style="list-style-type: none"> <li>● Modify the color settings.</li> <li>● Check the color system.</li> </ul>
The PC cannot be started. (This scenario is applicable only to panel models operating with the PC.)	<ul style="list-style-type: none"> <li>● Check whether the PC adapter is correctly connected and whether the PC is powered on.</li> <li>● Check whether the PC is connected correctly to the interactive panel.</li> </ul>

QOMO may modify the user manual without prior notice.

If you discover any unclear presentation, mistake or omission in this manual, please contact us immediately. QOMO is not liable for any loss or damage if you fail to contact us.



866-990-QOMO | 46950 Magelan Dr, Wixom, MI 48393 | info@qomo.com



/qomosolutions

Copyright ©2018 Qomo. All rights reserved. This document may not be copied in any form without permission from Qomo. Information in this document is subject to change without notice.