

BUNDLEBOARD H PANEL QUICK START GUIDE

1



Turn on System

Power Indicator: At the bottom right hand side of your panel frame there is a series of buttons. The first button on the left is the power button. When powered on, the indicator light will turn green.

2

Overview

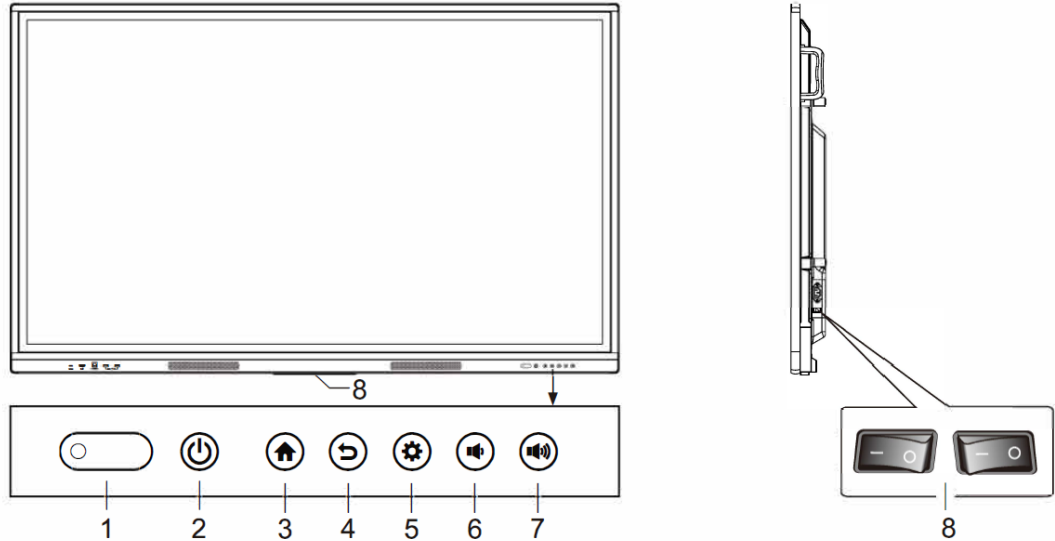

1. Indicator light, remote control receiver and light sensing receiver;
2. :Power;
3. : Homepage
4. : Return and touch unlock;
5. : Setting;
6. :Vol-;
7. : Vol+;
8. Switch.

3

Accessories

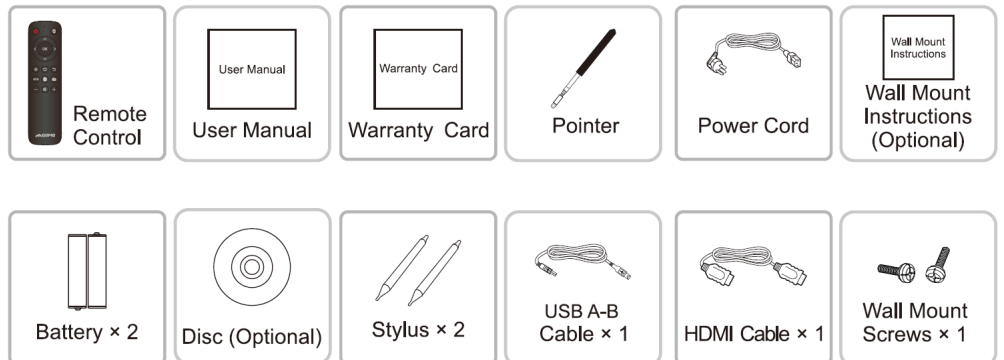

4

Remote Control



KEY	Function
POWER (⏻)	Switch between power-on and standby states
SOURCE (📡)	Open / close the signal source list
NAVIGATION KEYS (<> ^ v)	Select or adjust menu options
OK (OK)	Confirm the operation
MEUN (☰)	Show/hide the main menu
HOME (🏠)	Display the Android home page
BACK (⏪)	Return to the previous interface
OPS	Switch to OPS source
FREEZE (❄️)	Enable or disable freeze function in the system
SNAPSHOT (📷)	Take a screenshot
VOL- (⏮)	Decrease the volume
MUTE (🔇)	Enable/disable sound
VOL+ (⏭)	Increase the volume

1.The picture is for reference only, subject to the actual remote control.
2.Functions of keys on the remote control may vary, subject to actual functions.

5

Android Home Page

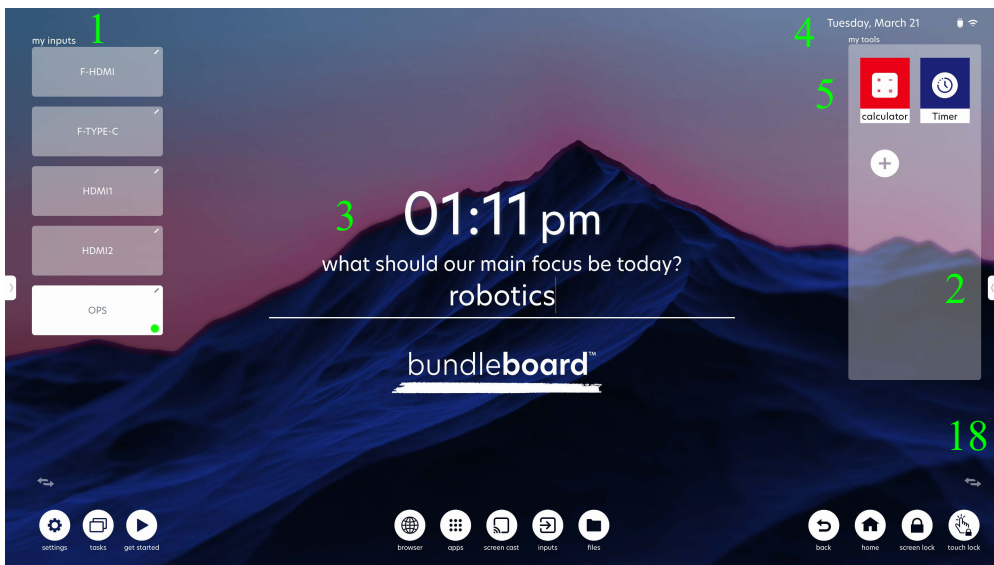

6 7 8

9 10 11 12 13

14 15 16 17

1. Inputs
2. Annotation & Tools
3. Time & Subject
4. Date & Wifi
5. Apps Shortcut
6. Settings
7. Show Running Apps
8. Get Started
9. Internet Browser
10. Additional Apps
11. Wireless Screen Cast
12. Inputs
13. File Manager
14. Back
15. Home
16. Lock
17. Turn Off Touch
18. Flip Tool Bar

6

Renaming Inputs of Home Screen



Tap upper right of input to rename

8

Set Start Up Channel

Setting up default input to power on to

1. Use remote control to select source (top right button), or click on "input" on swipe up menu
2. Click on "Source Settings" and select "Source When Power On"
3. Change to the desired and most frequently used input source

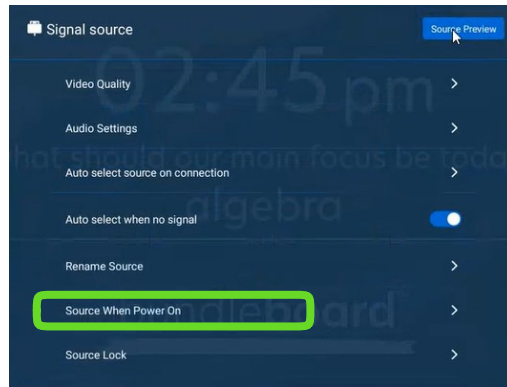

8

Settings

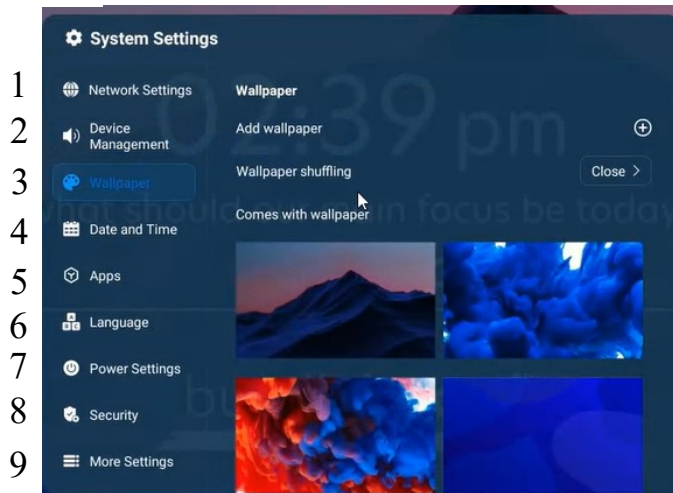

1. Wifi Settings: Set up wifi network, ethernet, bluetooth
2. Device Management: Set up external camera and microphone
3. Change Wallpaper: Choose from existing wallpaper or upload your own
4. Time Settings: Automatically or manually set time
5. Apps: App Management
6. Language Settings: Change language
7. Power Settings: Set power-on, power off, and standby modes and schedules
8. Security: Set and change lock password
9. More Settings: Lock options

9

Program Shut-Down Time

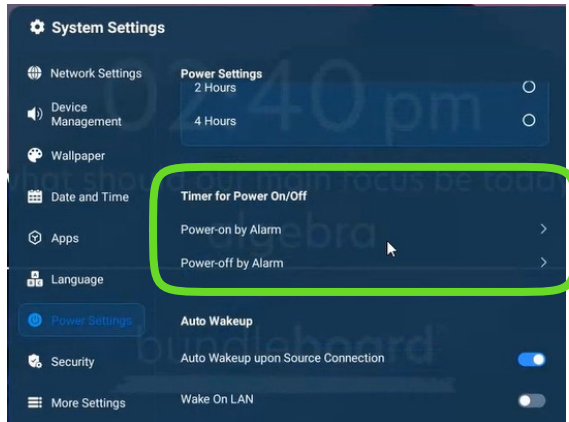

Schedule an automatic start up and shut down time to save energy by clicking on "Power-on by Alarm" and "Power-off by Alarm" under Power settings.

10

File Explorer

Access and save files (image, videos, pdf, etc) onto the screen by clicking on the file icon on the bottom swipe up menu.

Hold and press the icon inside the file explorer to move, copy, or delete.

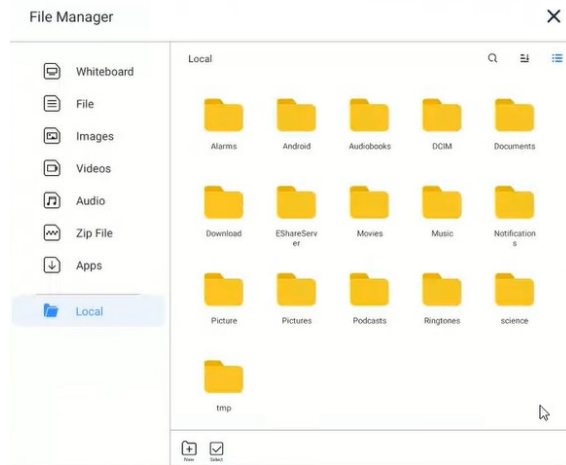

11

Whiteboard Annotation

Access pre-installed whiteboard app in side bar menu, or from apps page.
 *Note: You can activate palm erase using palm

	Side bar change left and right		More through QR code
	Previous page		Multi-point
	Next page		Import notes
	Add page		Save
	Hide bottom sidebar		Background Settings
	Brush setting		Eye protection
	Eraser		Quit
	Single point		
	Lasso Move		
	Import picture, Split screen writing, Pattern		
	Undo		
	Repeat		

12

Overlay Annotation & Tools

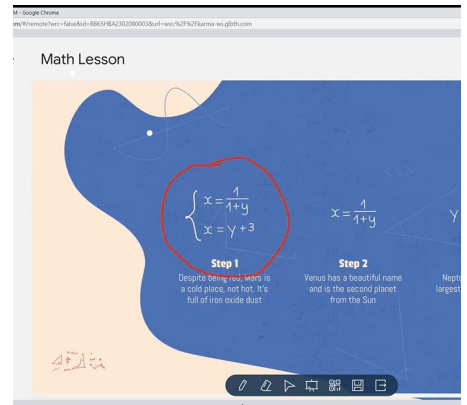
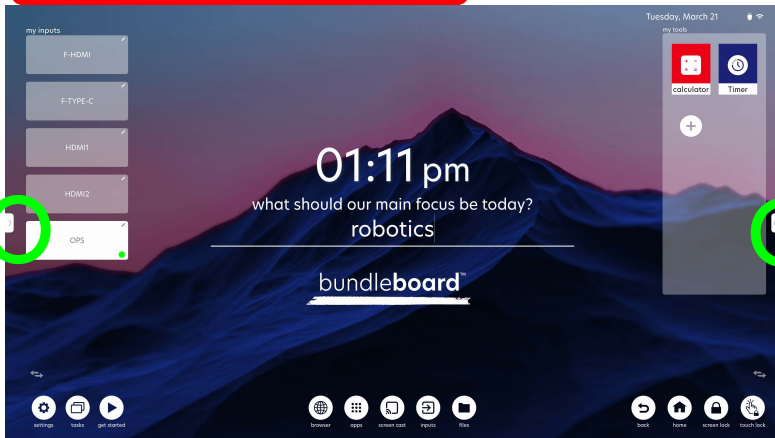

Annotate on top of any screen by clicking side arrow

Toolbar (left to right): Draw, Erase, Mouse, Dgital Whiteboard, QR Code share, Save, Exit

Palm erase also available using palm against the board

Note: The overlay annotation feature screen shots the document, it does not actually write inside the document.

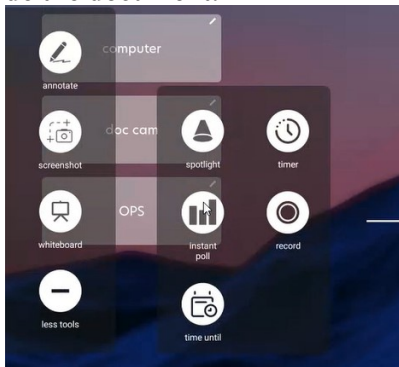

Access more fun tools such as spot light mode, timer, instant poling, screen recording, and countdown days

13

EShare App

EShare is a screen casting tool for smart phones, computers and tablets. Cast up to 9 different devices to screen. Windows and Mac devices enables touch control on the interactive screen.

1. Click on casting icon shown below



2. Also available by clicking apps, then the following icon



3. Install EShare on device such as computer or tablet by visiting eshare.app
4. Ensure all devices are connected to the same WIFI network.
5. Launch EShare on device and select EShare name shown on the panel.

Casting is also available with casts.app (don't need to be on same wireless network) to share window or browser. Also compatible with chrome cast, airplay, miracast.

14

Connecting Devices

1. Connecting Your External Computer

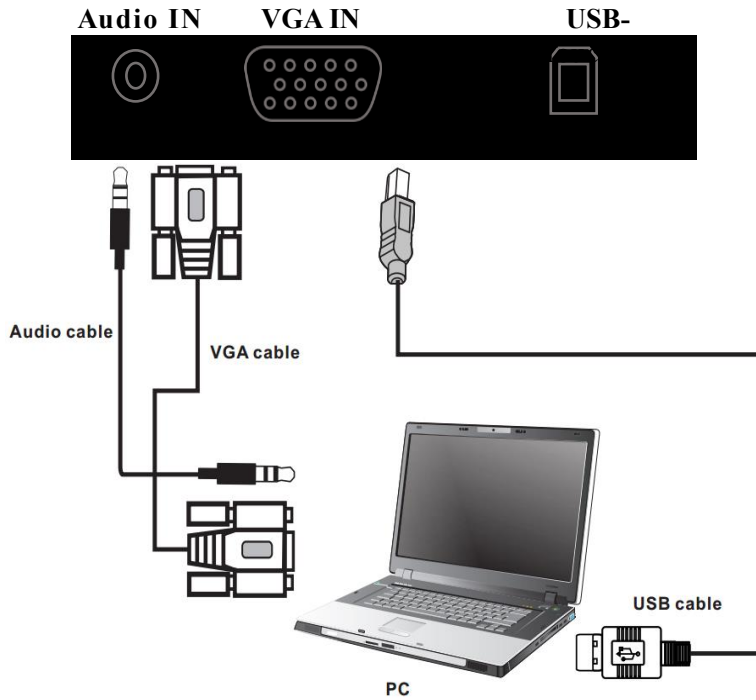

BundleBoard H now has USB-C port available to connect to computer using USB-C Cable for image and touch

Connect your computer using a USB touch cable, VGA Cable and Audio Cable, HDMI Cable or DP Cable.

2. Outputting Display

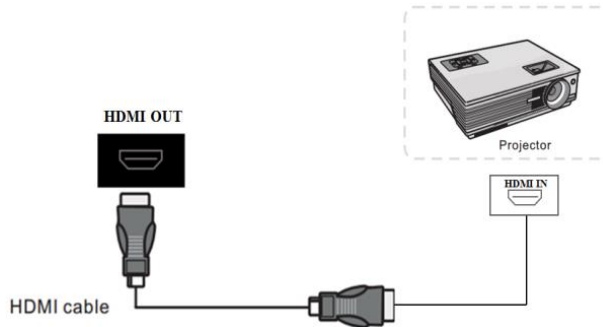

You can output your BundleBoard G panel to other displays through the HDMI port.

3. AV Connecting(HDMI IN)

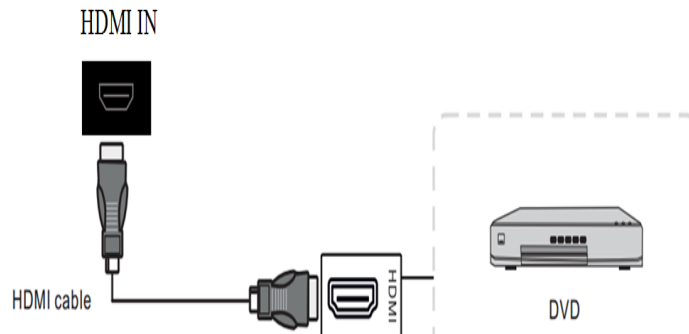

Connect other external devices to the panel such as a DVD player or Camera using the HDMI port.

ENJOY YOUR BUNDLEBOARD H

For Additional Help

Contact us at support@qomo.com

or 248-960-0985

Visit us at www.qomo.com for training videos and more!