

**Important
warnings
before use**

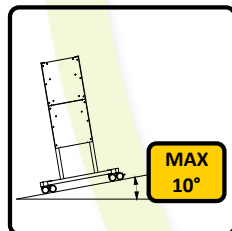

**WARNING
MAXIMUM SLOPE
10 DEGREES**

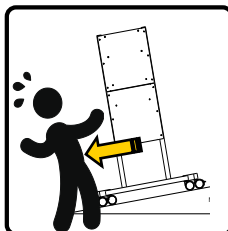

**WARNING
DO NOT PULL DOWN
SLOPE**

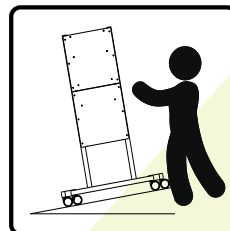









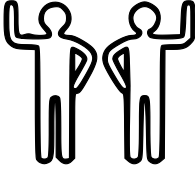
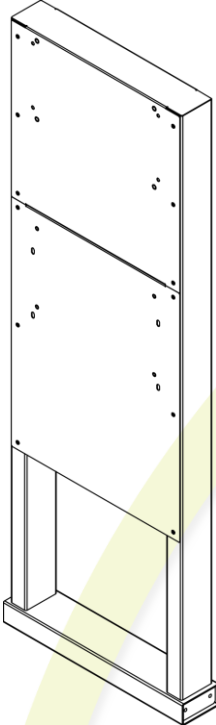
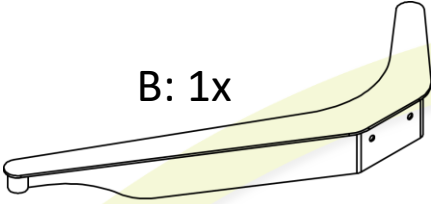
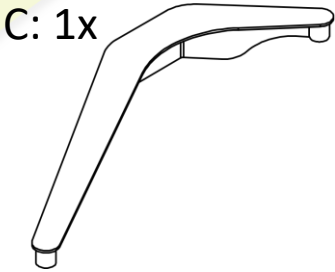



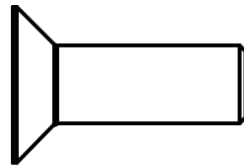

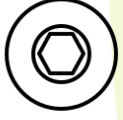
**STAY ABOVE CART
WHEN MOVING
DOWN SLOPE**

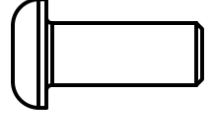
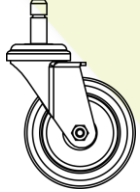
Installation manual

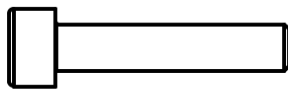
Mobile Stand Mix

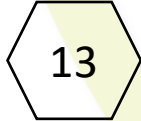
for BalanceBox®400

Safety Instructions	What's in the box		
 	<p>A: 1x</p> 	<p>B: 1x</p>  <p>C: 1x</p> 	
<p>1x</p> 			
	<div style="border: 1px solid black; padding: 5px; width: fit-content; margin: auto;"> <p>Ø75 mm / Ø3" Casters</p>  </div>		
<p>F: 4x M10x30</p>   	<p>D: 2x</p> 		
<p>G: 4x M8x20</p>   	<p>E: 2x</p> 		
<p>H: 2x M6x30</p>   			
<p>K: 4x M8</p>   			

1

Assemble the wheelbase and column

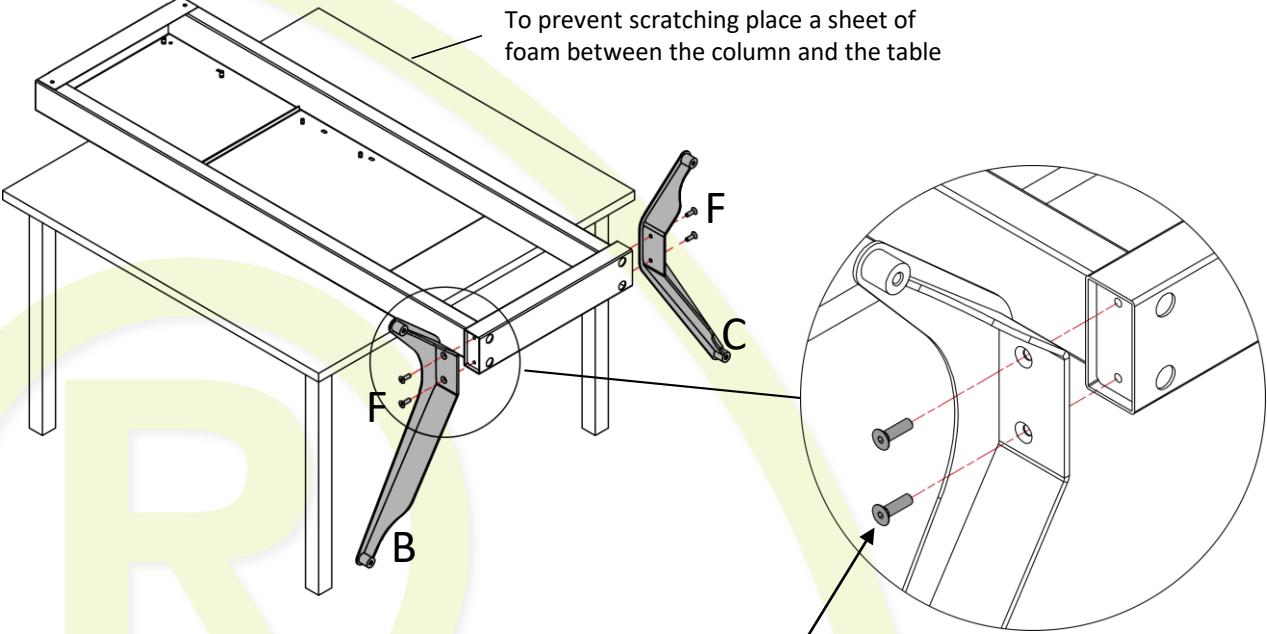

F: 4x M10x30

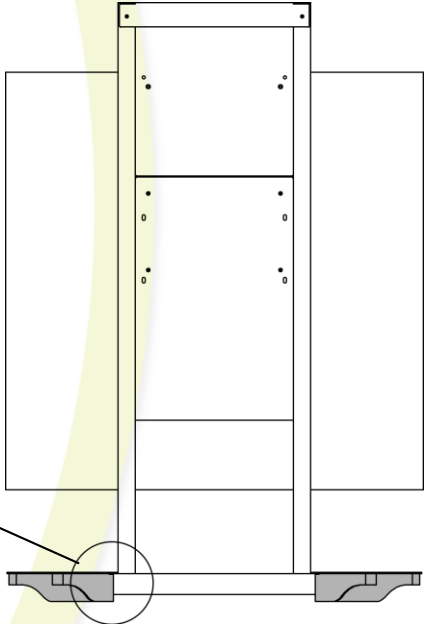
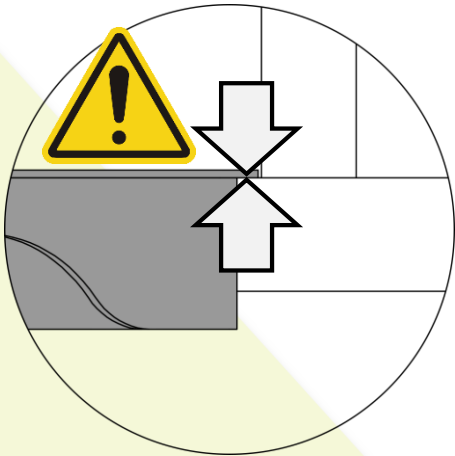
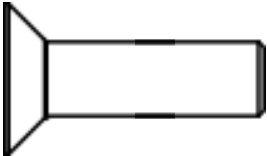

Make sure the top plate of each leg touches the topside of the cross beam before tightening the screws

3

2

Mount the casters

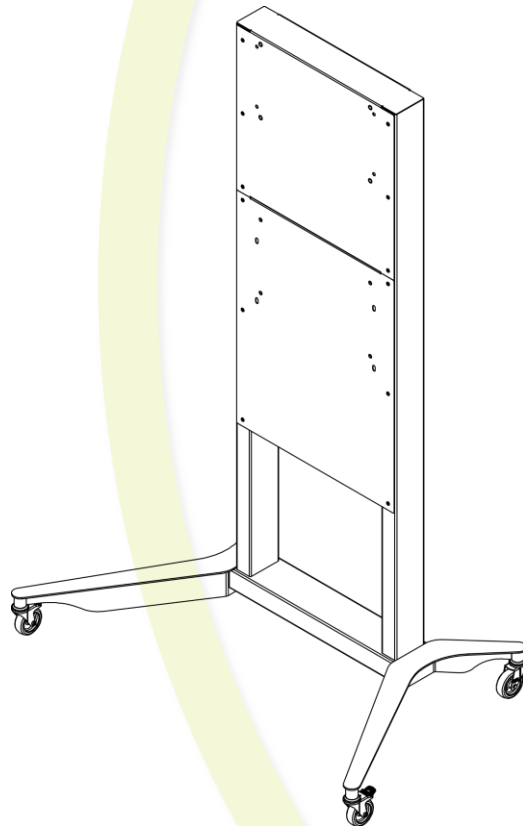
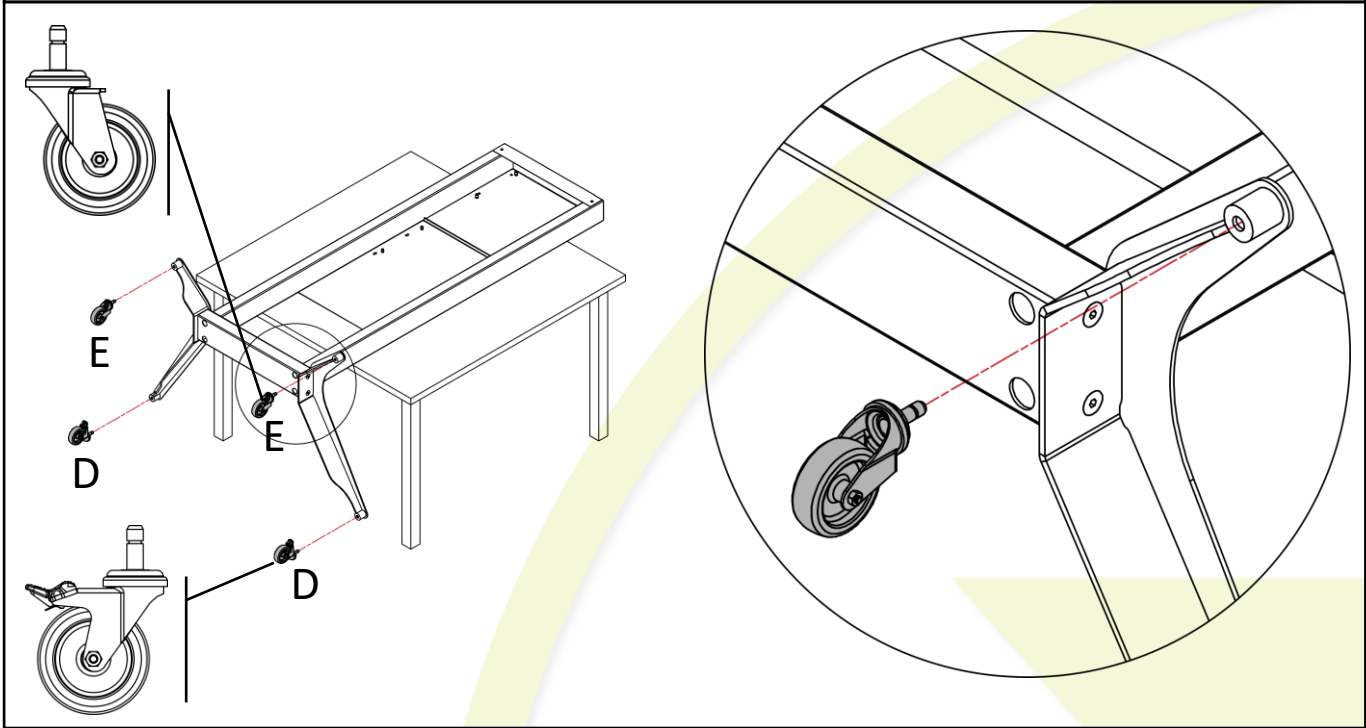

4

3

Mounting BalanceBox®400* on the Mobile stand
(*not included)

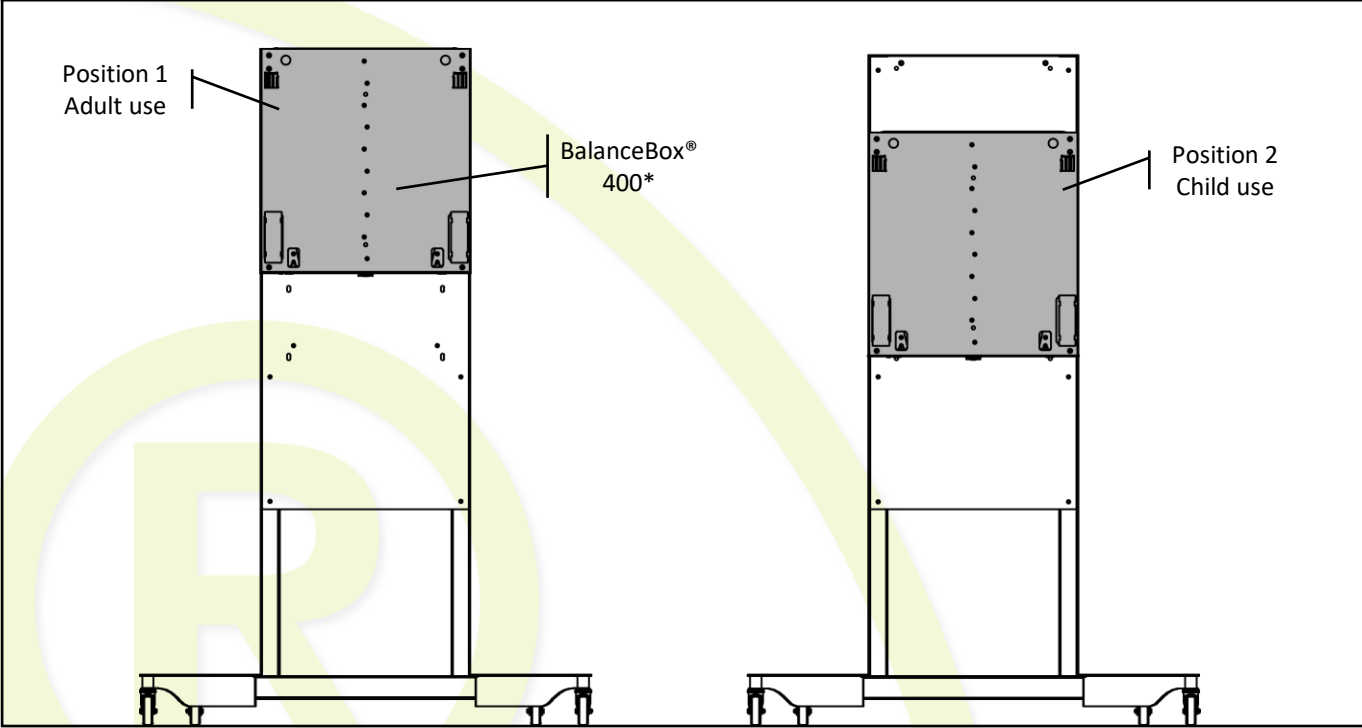

4

Mount the BalanceBox®400* at the desired position

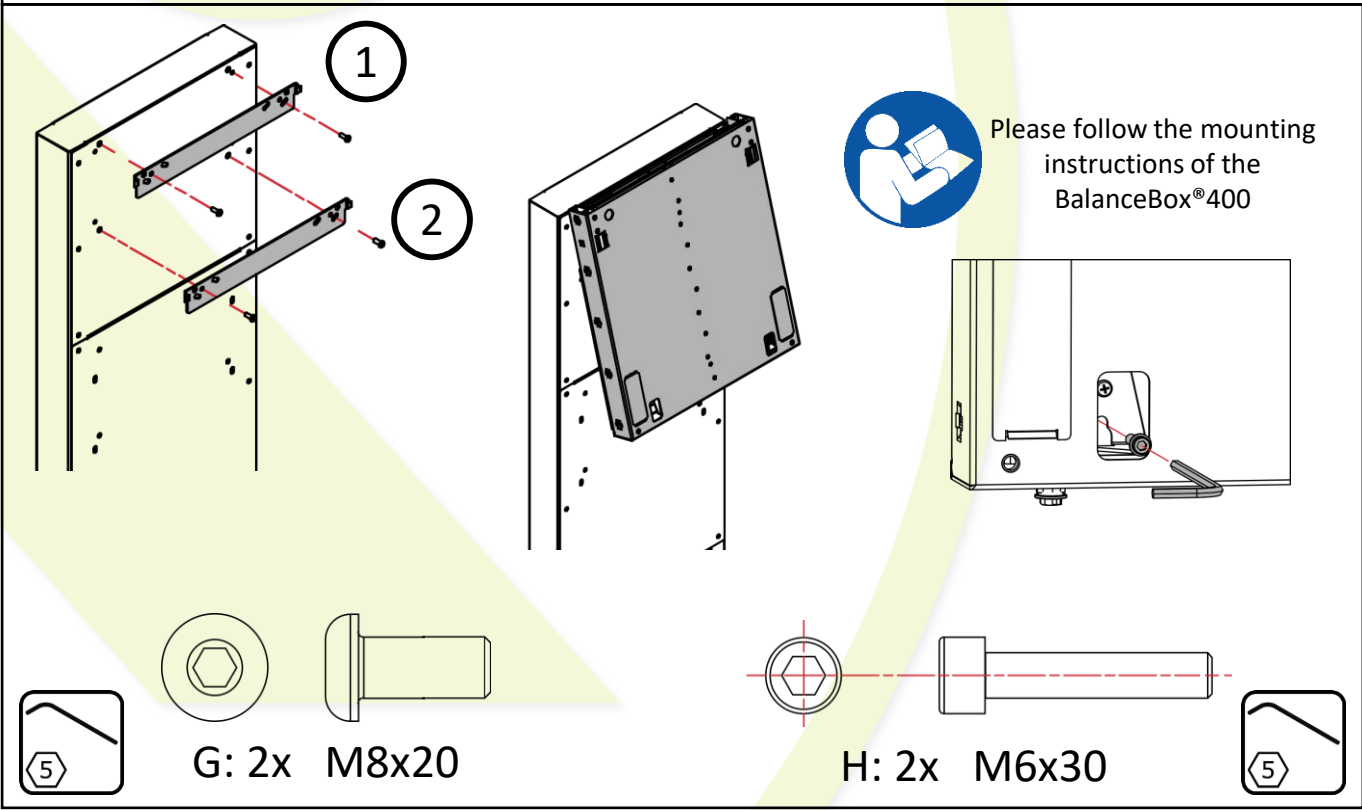

5

Mounting VESA bracket 481A70* on the Mobile Stand
(*not included)

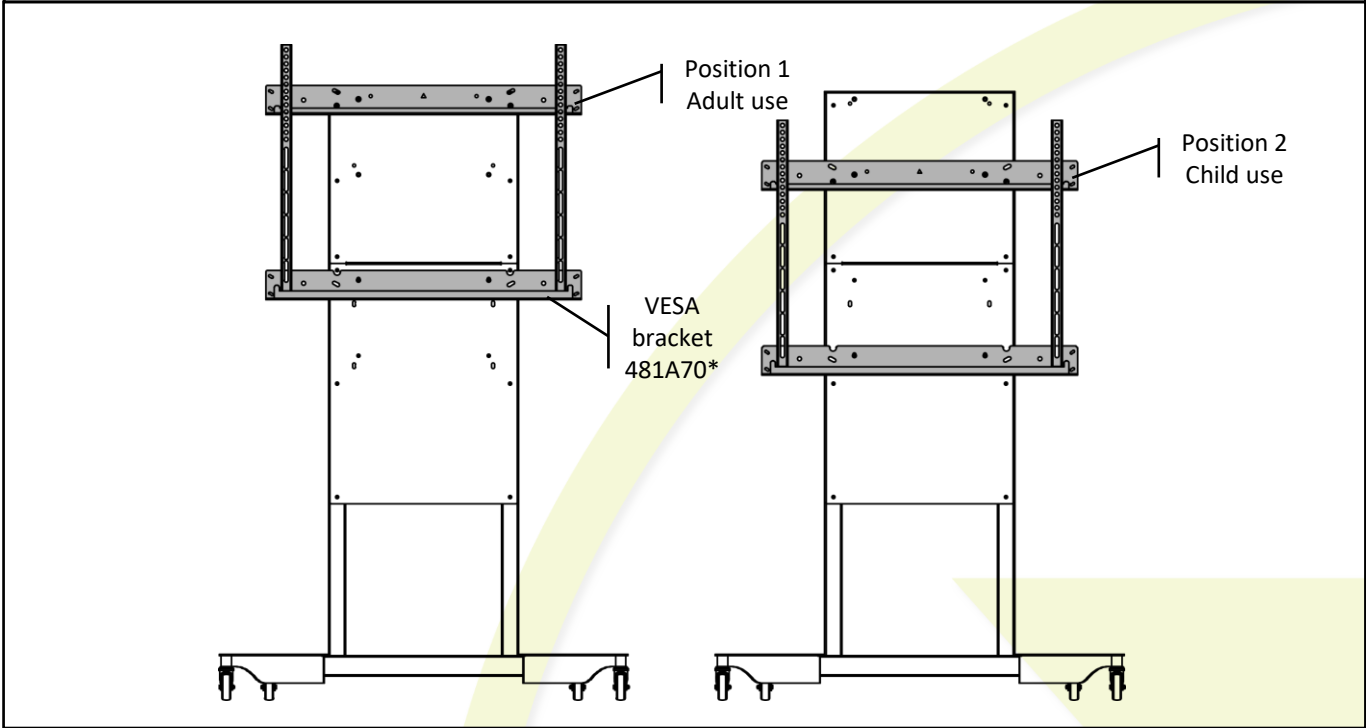

6

Mount the VESA bracket 481A70

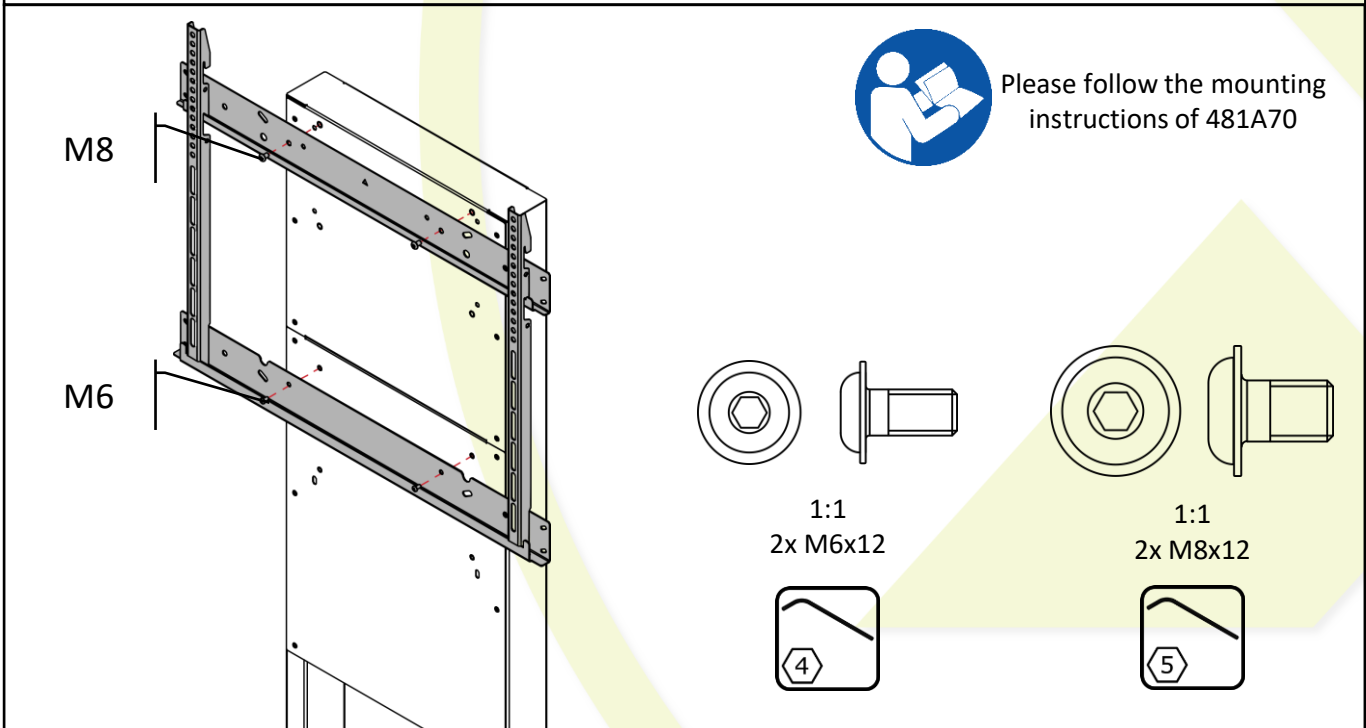

6

7

Mounting 3rd party VESA bracket on the Mobile Stand
(*not included)

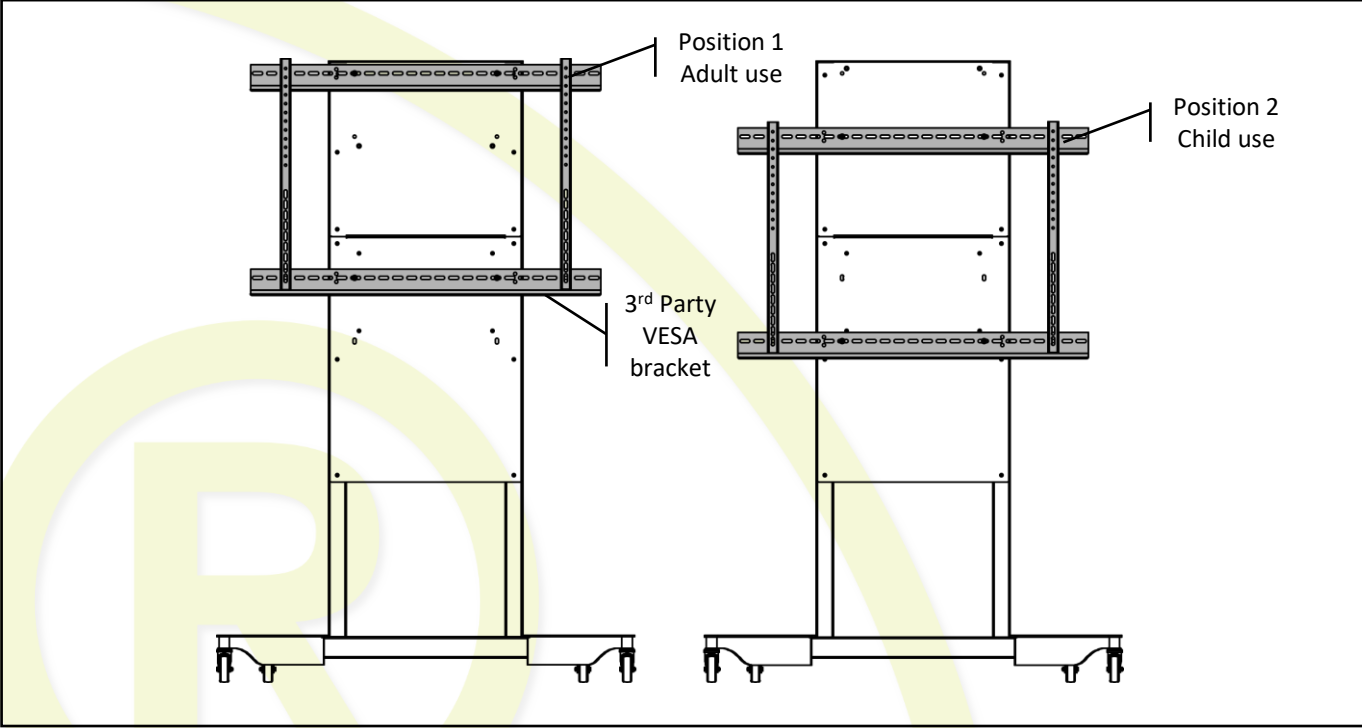

8

Mount the 3rd party VESA bracket

